

Your Global Automation Partner

# TURCK

## Overview Field-Wireable Connectors

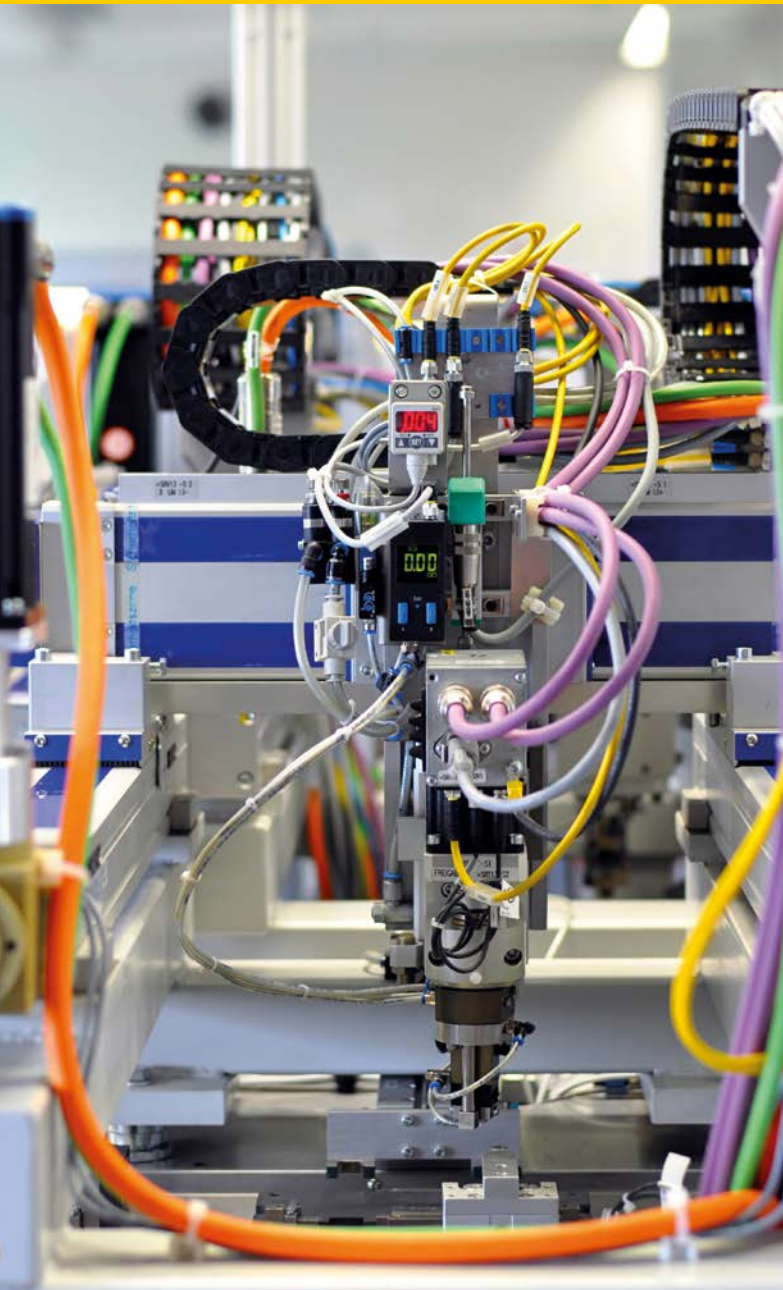

Field-Wireable Connectors

Contents



<b>Sensor- and Actuator-Connection</b>	
M8	4
M12	8
M12 for Duo-cable	14
7/8"	16
M16	18
M23	20
<b>Valve Connector</b>	
Valve Connector	22
<b>PROFIBUS-DP</b>	
M12	24
Sub-D	24
<b>CAN/DeviceNet</b>	
M12	26
7/8"	26
<b>Ethernet</b>	
M8	28
M12	28
RJ45	28
<b>Foundation Fieldbus/PROFIBUS-PA</b>	
M12	30
<b>AIDA</b>	
M12 Safety	32
RJ45 Push Pull	32
Power Push Pull	32
<b>Power Supply</b>	
7/8"	34
M16	34

# Sensor- and Actuator-Connection

M8, A-coded

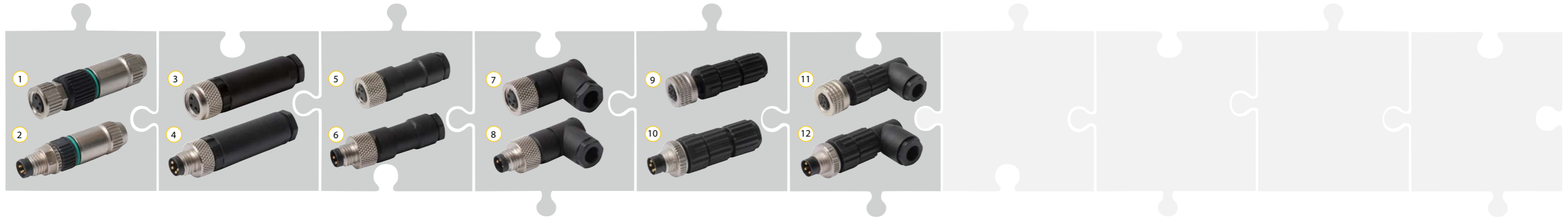

Ident-No.	Type Code	Gender	Design	Pins	Cable Feedthrough	Terminal Capacity	Connection	Housing	Coupling Nut	Availability
6905404 ①	HA5131-0	Female	Straight	3	2.5...5.1 mm	0.14...0.34 mm <sup>2</sup>	IDC	Plastic	Brass	•
6905405 ①	HA5141-0	Female	Straight	4	2.5...5.1 mm	0.14...0.34 mm <sup>2</sup>	IDC	Plastic	Brass	•
6905402 ②	HAS5131-0	Male	Straight	3	2.5...5.1 mm	0.14...0.34 mm <sup>2</sup>	IDC	Plastic	Brass	•
6905403 ②	HAS5141-0	Male	Straight	4	2.5...5.1 mm	0.14...0.34 mm <sup>2</sup>	IDC	Plastic	Brass	•
6901030 ③	B5133-0	Female	Straight	3	3.5...5.0 mm	0.14...0.5 mm <sup>2</sup>	Screw terminal connection	Plastic	Die-cast zinc	•
6901031 ③	B5143-0	Female	Straight	4	3.5...5.0 mm	0.14...0.5 mm <sup>2</sup>	Screw terminal connection	Plastic	Die-cast zinc	•
6901012 ④	BS5133-0	Male	Straight	3	3.5...5.0 mm	0.14...0.5 mm <sup>2</sup>	Screw terminal connection	Plastic	Die-cast zinc	•
6901013 ④	BS5143-0	Male	Straight	4	3.5...5.0 mm	0.14...0.5 mm <sup>2</sup>	Screw terminal connection	Plastic	Die-cast zinc	•
6904910 ⑤	B5131-0	Female	Straight	3	3.5...5.0 mm	0.14...0.25 mm <sup>2</sup>	Solder contact	Plastic	Die-cast zinc	•
6904915 ⑤	B5141-0	Female	Straight	4	3.5...5.0 mm	0.14...0.25 mm <sup>2</sup>	Solder contact	Plastic	Die-cast zinc	•
6901010 ⑥	BS5131-0	Male	Straight	3	3.5...5.0 mm	0.14...0.25 mm <sup>2</sup>	Solder contact	Plastic	Die-cast zinc	•
6901011 ⑥	BS5141-0	Male	Straight	4	3.5...5.0 mm	0.14...0.25 mm <sup>2</sup>	Solder contact	Plastic	Die-cast zinc	•
6904810 ⑦	B5231-0	Female	Angled	3	3.5...5.0 mm	0.14...0.25 mm <sup>2</sup>	Solder contact	Plastic	Die-cast zinc	•
6904815 ⑦	B5241-0	Female	Angled	4	3.5...5.0 mm	0.14...0.25 mm <sup>2</sup>	Solder contact	Plastic	Die-cast zinc	•
6901110 ⑧	BS5231-0	Male	Angled	3	3.5...5.0 mm	0.14...0.25 mm <sup>2</sup>	Solder contact	Plastic	Die-cast zinc	•
6901111 ⑧	BS5241-0	Male	Angled	4	3.5...5.0 mm	0.14...0.25 mm <sup>2</sup>	Solder contact	Plastic	Die-cast zinc	-
6902700 ⑨	H5131-0	Female	Straight	3	4.0...5.0 mm	0.14...0.34 mm <sup>2</sup>	Piercing technology	Plastic	Zinc-Aluminum	•
6902720 ⑨	H5141-0	Female	Straight	4	4.0...5.0 mm	0.14...0.34 mm <sup>2</sup>	Piercing technology	Plastic	Zinc-Aluminum	•
6902710 ⑩	HS5131-0	Male	Straight	3	4.0...5.0 mm	0.14...0.34 mm <sup>2</sup>	Piercing technology	Plastic	Zinc-Aluminum	•
6902730 ⑩	HS5141-0	Male	Straight	4	4.0...5.0 mm	0.14...0.34 mm <sup>2</sup>	Piercing technology	Plastic	Zinc-Aluminum	•
6902800 ⑪	H5231-0	Female	Angled	3	4.0...5.0 mm	0.14...0.34 mm <sup>2</sup>	Piercing technology	Plastic	Zinc-Aluminum	•
6902820 ⑪	H5241-0	Female	Angled	4	4.0...5.0 mm	0.14...0.34 mm <sup>2</sup>	Piercing technology	Plastic	Zinc-Aluminum	•
6902810 ⑫	HS5231-0	Male	Angled	3	4.0...5.0 mm	0.14...0.34 mm <sup>2</sup>	Piercing technology	Plastic	Zinc-Aluminum	•
6902830 ⑫	HS5241-0	Male	Angled	4	4.0...5.0 mm	0.14...0.34 mm <sup>2</sup>	Piercing technology	Plastic	Zinc-Aluminum	-

# Sensor- and Actuator-Connection

M8, A-coded | Continuation



Ident-No.	Type Code	Gender	Design	Pins	Cable Feedthrough	Terminal Capacity	Connection	Housing	Coupling Nut	Availability
6935010 ①	FW-M8ST4-G-SB-ME-SH-6.5	Male	Straight	4	5.0...6.5 mm	0.14...0.5 mm <sup>2</sup>	Screw terminal connection	Brass	Brass	•
100002292 ②	FW-PRKPM0320-SA-S-0406	Female	Straight	3	4.0 ... 5.5 mm	0.14 ... 0.5 mm <sup>2</sup>	Screw terminal connection	Plastic	Brass	•
100002293 ②	FW-PRKPM0420-SA-S-0406	Female	Straight	4	4.0 ... 5.5 mm	0.14 ... 0.5 mm <sup>2</sup>	Screw terminal connection	Plastic	Brass	•
100002294 ③	FW-PRSPM0320-SA-S-0406	Male	Straight	3	4.0 ... 5.5 mm	0.14 ... 0.5 mm <sup>2</sup>	Screw terminal connection	Plastic	Brass	•
100002295 ③	FW-PRSPM0420-SA-S-0406	Male	Straight	4	4.0 ... 5.5 mm	0.14 ... 0.5 mm <sup>2</sup>	Screw terminal connection	Plastic	Brass	•



# Sensor- and Actuator-Connection

M12, A-coded

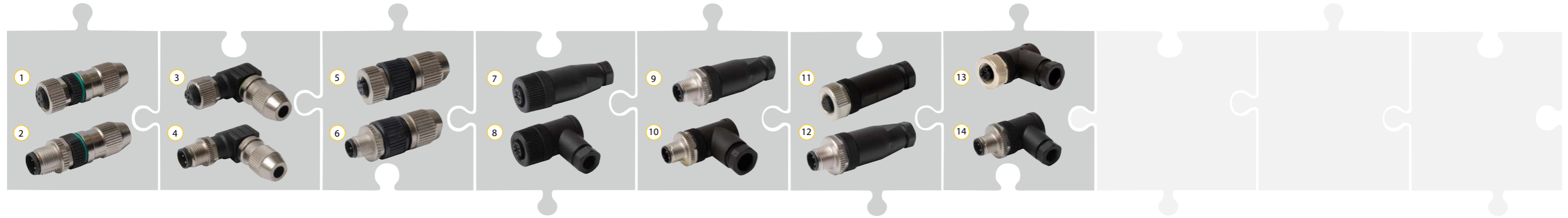

Ident-No.	Type Code	Gender	Design	Pins	Cable Feedthrough	Terminal Capacity	Connection	Housing	Coupling Nut	Availability
6905407 ①	HA8141-0	Female	Straight	4	4.0...5.1 mm	0.14...0.34 mm <sup>2</sup>	IDC	Plastic	Brass	•
6905406 ②	HAS8141-0	Male	Straight	4	4.0...5.1 mm	0.14...0.34 mm <sup>2</sup>	IDC	Plastic	Brass	•
6905401 ③	HA8241-0	Female	Angled	4	4.0...5.1 mm	0.14...0.34 mm <sup>2</sup>	IDC	Plastic	Brass	•
6905400 ④	HAS8241-0	Male	Angled	4	4.0...5.1 mm	0.14...0.34 mm <sup>2</sup>	IDC	Plastic	Brass	•
6905409 ⑤	HA8141-16	Female	Straight	4	6.0...8.0 mm	0.34...0.75 mm <sup>2</sup>	IDC	Plastic	Brass	-
6905408 ⑥	HAS8141-16	Male	Straight	4	6.0...8.0 mm	0.34...0.75 mm <sup>2</sup>	IDC	Plastic	Brass	-
69049 ⑦	B8141-0	Female	Straight	4	4.0...6.0 mm	0.14...0.75 mm <sup>2</sup>	Screw terminal connection	Plastic	Plastic	•
6904601 ⑦	B8151-0	Female	Straight	5	4.0...6.0 mm	0.14...0.75 mm <sup>2</sup>	Screw terminal connection	Plastic	Plastic	•
69048 ⑧	B8241-0	Female	Angled	4	4.0...6.0 mm	0.14...0.75 mm <sup>2</sup>	Screw terminal connection	Plastic	Plastic	•
6904602 ⑧	B8251-0	Female	Angled	5	4.0...6.0 mm	0.14...0.75 mm <sup>2</sup>	Screw terminal connection	Plastic	Plastic	•
6904901 ⑦	B8141-0/PG9	Female	Straight	4	6.0...8.0 mm	0.14...0.75 mm <sup>2</sup>	Screw terminal connection	Plastic	Plastic	•
6904604 ⑦	B8151-0/9	Female	Straight	5	6.0...8.0 mm	0.14...0.75 mm <sup>2</sup>	Screw terminal connection	Plastic	Plastic	•
6904801 ⑧	B8241-0/PG9	Female	Angled	4	6.0...8.0 mm	0.14...0.75 mm <sup>2</sup>	Screw terminal connection	Plastic	Plastic	•
6904603 ⑧	B8251-0/9	Female	Angled	5	6.0...8.0 mm	0.14...0.75 mm <sup>2</sup>	Screw terminal connection	Plastic	Plastic	•
69010 ⑨	BS8141-0	Male	Straight	4	4.0...6.0 mm	0.14...0.75 mm <sup>2</sup>	Screw terminal connection	Plastic	Die-cast zinc	•
6904611 ⑨	BS8151-0	Male	Straight	5	4.0...6.0 mm	0.14...0.75 mm <sup>2</sup>	Screw terminal connection	Plastic	Die-cast zinc	•
69011 ⑩	BS8241-0	Male	Angled	4	4.0...6.0 mm	0.14...0.75 mm <sup>2</sup>	Screw terminal connection	Plastic	Die-cast zinc	•
6904612 ⑩	BS8251-0	Male	Angled	5	4.0...6.0 mm	0.14...0.75 mm <sup>2</sup>	Screw terminal connection	Plastic	Die-cast zinc	•
6901003 ⑨	BS8141-0/PG9	Male	Straight	4	6.0...8.0 mm	0.14...0.75 mm <sup>2</sup>	Screw terminal connection	Plastic	Die-cast zinc	•
6901103 ⑩	BS8241-0/PG9	Male	Angled	4	6.0...8.0 mm	0.14...0.75 mm <sup>2</sup>	Screw terminal connection	Plastic	Die-cast zinc	-
6904615 ⑩	BS8251-0/9	Male	Angled	5	6.0...8.0 mm	0.14...0.75 mm <sup>2</sup>	Screw terminal connection	Plastic	Die-cast zinc	•
6904605 ⑪	B8181-0	Female	Straight	8	6.0...8.0 mm	0.14...0.5 mm <sup>2</sup>	Screw terminal connection	Plastic	Die-cast zinc	•
6901004 ⑫	BS8181-0	Male	Straight	8	6.0...8.0 mm	0.14...0.5 mm <sup>2</sup>	Screw terminal connection	Plastic	Die-cast zinc	•
6934339 ⑬	B8281-0	Female	Angled	8	6.0...8.0 mm	0.14...0.5 mm <sup>2</sup>	Screw terminal connection	Plastic	Die-cast zinc	-
6930862 ⑭	BS8281-0	Male	Angled	8	6.0...8.0 mm	0.14...0.5 mm <sup>2</sup>	Screw terminal connection	Plastic	Die-cast zinc	-

# Sensor- and Actuator-Connection

M12, A-coded | Continuation

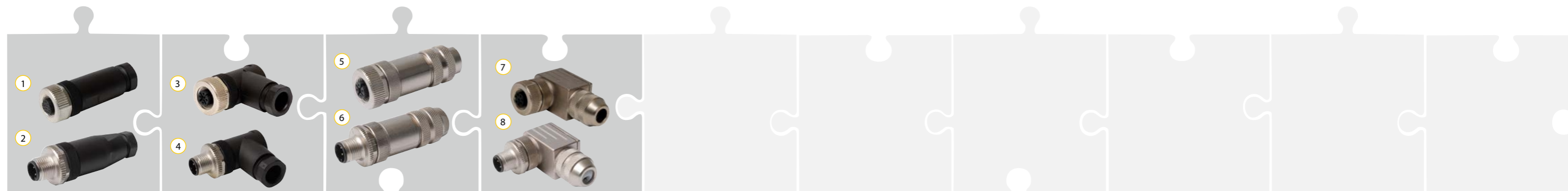

Ident-No.	Type Code	Gender	Design	Pins	Cable Feedthrough	Terminal Capacity	Connection	Housing	Coupling Nut	Availability
6604052 ①	B81121-0/PG9	Female	Straight	12	6.0...8.0 mm	0.14...0.25 mm <sup>2</sup>	Solder contact	Plastic	Die-cast zinc	-
6604053 ②	BS81121-0/PG9	Male	Straight	12	6.0...8.0 mm	0.14...0.25 mm <sup>2</sup>	Solder contact	Plastic	Die-cast zinc	-
6936122 ④	BS82121-0/PG9	Male	Angled	12	6.0...8.0 mm	0.14...0.25 mm <sup>2</sup>	Solder contact	Plastic	Die-cast zinc	•
6933589 ②	BMS8141-0	Male	Straight	4	2.5...3.5 mm	0.25...0.75 mm <sup>2</sup>	Screw terminal connection	Plastic	Die-cast zinc	-
6935145 ①	BM8141-0	Female	Straight	4	4.0...6.0 mm	0.25...0.75 mm <sup>2</sup>	Screw terminal connection	Plastic	Die-cast zinc	•
6935888 ①	BM8151-0	Female	Straight	5	4.0...6.0 mm	0.25...0.75 mm <sup>2</sup>	Screw terminal connection	Plastic	Die-cast zinc	•
6935889 ③	BM8241-0	Female	Angled	4	4.0...6.0 mm	0.25...0.75 mm <sup>2</sup>	Screw terminal connection	Plastic	Die-cast zinc	•
6935890 ③	BM8251-0	Female	Angled	5	4.0...6.0 mm	0.25...0.75 mm <sup>2</sup>	Screw terminal connection	Plastic	Die-cast zinc	•
6936159 ①	BM8141-0/PG9	Female	Straight	4	6.0...8.0 mm	0.14...0.75 mm <sup>2</sup>	Screw terminal connection	Plastic	Die-cast zinc	-
6604162 ①	BM8151-0/PG9	Female	Straight	5	6.0...8.0 mm	0.14...0.75 mm <sup>2</sup>	Screw terminal connection	Plastic	Die-cast zinc	-
6930375 ⑤	CMB8141-0	Female	Straight	4	6.0...8.0 mm	0.14...0.75 mm <sup>2</sup>	Screw terminal connection	Die-cast zinc	Die-cast zinc	•
6930145 ⑤	CMB8151-0	Female	Straight	5	6.0...8.0 mm	0.14...0.75 mm <sup>2</sup>	Screw terminal connection	Die-cast zinc	Die-cast zinc	•
6931450 ⑤	CMB8181-0	Female	Straight	8	6.0...8.0 mm	0.14...0.5 mm <sup>2</sup>	Screw terminal connection	Die-cast zinc	Die-cast zinc	•
6930792 ⑥	CMBS8181-0	Male	Straight	8	6.0...8.0 mm	0.14...0.5 mm <sup>2</sup>	Screw terminal connection	Die-cast zinc	Die-cast zinc	•
6604005 ⑥	CMBS8141-0	Male	Straight	4	6.0...8.0 mm	0.14...0.75 mm <sup>2</sup>	Screw terminal connection	Die-cast zinc	Die-cast zinc	•
6930161 ⑥	CMBS8151-0	Male	Straight	5	6.0...8.0 mm	0.14...0.75 mm <sup>2</sup>	Screw terminal connection	Die-cast zinc	Die-cast zinc	•
6932405 ⑦	CMB8241-0	Female	Angled	4	6.0...8.0 mm	0.14...0.75 mm <sup>2</sup>	Screw terminal connection	Die-cast zinc	Die-cast zinc	-
6930215 ⑦	CMB8251-0	Female	Angled	5	6.0...8.0 mm	0.14...0.75 mm <sup>2</sup>	Screw terminal connection	Die-cast zinc	Die-cast zinc	•
6932024 ⑦	CMB8281-0	Female	Angled	8	6.0...8.0 mm	0.14...0.5 mm <sup>2</sup>	Screw terminal connection	Die-cast zinc	Die-cast zinc	•
6932581 ⑧	CMBS8241-0	Male	Angled	4	6.0...8.0 mm	0.14...0.75 mm <sup>2</sup>	Screw terminal connection	Die-cast zinc	Die-cast zinc	-
6930216 ⑧	CMBS8251-0	Male	Angled	5	6.0...8.0 mm	0.14...0.75 mm <sup>2</sup>	Screw terminal connection	Die-cast zinc	Die-cast zinc	-

# Sensor- and Actuator-Connection

M12, A-coded | Continuation

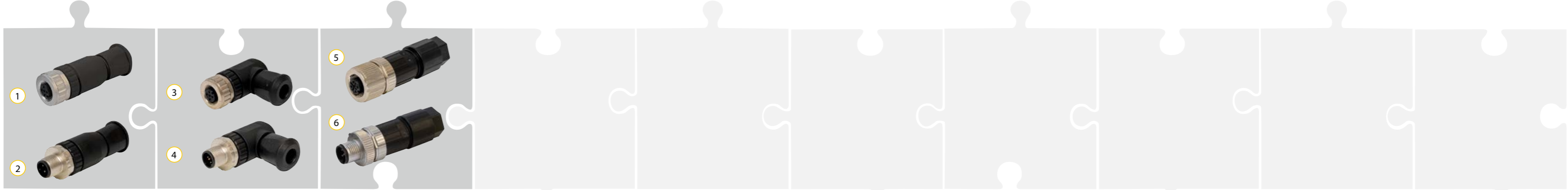

Ident-No.	Type Code	Gender	Design	Pins	Cable Feedthrough	Terminal Capacity	Connection	Housing	Coupling Nut	Availability
100002283 ①	FW-ERKPM0416-SA-S-0408	Female	Straight	4	4.0 ... 8.0 mm	0.25 ... 1.5 mm <sup>2</sup>	Screw terminal connection	Plastic	Brass	•
100002285 ①	FW-ERKPM0516-SA-S-0408	Female	Straight	5	4.0 ... 8.0 mm	0.25 ... 1.5 mm <sup>2</sup>	Screw terminal connection	Plastic	Brass	•
100002286 ③	FW-EWKPM0416-SA-S-0408	Female	Angled	4	4.0 ... 8.0 mm	0.25 ... 1.5 mm <sup>2</sup>	Screw terminal connection	Plastic	Brass	•
100002287 ③	FW-EWKPM0516-SA-S-0408	Female	Angled	5	4.0 ... 8.0 mm	0.25 ... 1.5 mm <sup>2</sup>	Screw terminal connection	Plastic	Brass	•
100002288 ②	FW-ERSPM0416-SA-S-0408	Male	Straight	4	4.0 ... 8.0 mm	0.25 ... 1.5 mm <sup>2</sup>	Screw terminal connection	Plastic	Brass	•
100002289 ②	FW-ERSPM0516-SA-S-0408	Male	Straight	5	4.0 ... 8.0 mm	0.25 ... 1.5 mm <sup>2</sup>	Screw terminal connection	Plastic	Brass	•
100002290 ④	FW-EWSPM0416-SA-S-0408	Male	Angled	4	4.0 ... 8.0 mm	0.25 ... 1.5 mm <sup>2</sup>	Screw terminal connection	Plastic	Brass	•
100002291 ④	FW-EWSPM0516-SA-S-0408	Male	Angled	5	4.0 ... 8.0 mm	0.25 ... 1.5 mm <sup>2</sup>	Screw terminal connection	Plastic	Brass	•
100002047 ⑤	FW-ERKPM0426-SA-P-0408	Female	Straight	4	4.0 ... 8.0 mm	0.14 ... 0.75 mm <sup>2</sup>	Push in	Plastic	Brass	•
100002534 ⑤	FW-ERKPM0526-SA-P-0408	Female	Straight	5	4.0 ... 8.0 mm	0.14 ... 0.75 mm <sup>2</sup>	Push in	Plastic	Brass	•
100002048 ⑥	FW-ERSPM0426-SA-P-0408	Male	Straight	4	4.0 ... 8.0 mm	0.14 ... 0.75 mm <sup>2</sup>	Push in	Plastic	Brass	•
100002535 ⑥	FW-ERSPM0526-SA-P-0408	Male	Straight	5	4.0 ... 8.0 mm	0.14 ... 0.75 mm <sup>2</sup>	Push in	Plastic	Brass	•

# Sensor- and Actuator-Connection

M12 for Duo-cable, A-coded



Ident-No.	Type Code	Gender	Design	Pins	Cable Feedthrough	Terminal Capacity	Connection	Housing	Coupling Nut	Availability
6934720 ①	VBB8141-0	Female	Straight	4	2.1...3.0/4.0...5.0 mm	0.14...0.75 mm <sup>2</sup>	Screw terminal connection	Plastic	Die-cast zinc	-
6934722 ①	VBB8151-0	Female	Straight	5	2.1...3.0/4.0...5.0 mm	0.14...0.75 mm <sup>2</sup>	Screw terminal connection	Plastic	Die-cast zinc	-
6930061 ②	VBS8141-0	Male	Straight	4	2.1...3.0/4.0...5.0 mm	0.14...0.75 mm <sup>2</sup>	Screw terminal connection	Plastic	Die-cast zinc	•
6934721 ②	VBS8151-0	Male	Straight	5	2.1...3.0/4.0...5.0 mm	0.14...0.75 mm <sup>2</sup>	Screw terminal connection	Plastic	Die-cast zinc	-
6930073 ③	DBS8141-0	Male	Straight	4	2.1...3.0/4.0...5.0 mm	0.14...0.75 mm <sup>2</sup>	Screw terminal connection	Plastic	Plastic	-



# Sensor- and Actuator-Connection

7/8"



Ident-No.	Type Code	Gender	Design	Pins	Cable Feedthrough	Terminal Capacity	Connection	Housing	Coupling Nut	Availability
6914501 ①	B4131-0/9	Female	Straight	3	6.0...8.0 mm	0.14...1.0 mm <sup>2</sup>	Screw terminal connection	Plastic	Aluminum	•
6914504 ①	B4141-0/9	Female	Straight	4	6.0...8.0 mm	0.14...1.0 mm <sup>2</sup>	Screw terminal connection	Plastic	Aluminum	•
6914502 ②	BS4131-0/9	Male	Straight	3	6.0...8.0 mm	0.14...1.0 mm <sup>2</sup>	Screw terminal connection	Plastic	Aluminum	-
6914550 ②	BS4140-0/9	Male	Straight	4	6.0...8.0 mm	0.14...1.0 mm <sup>2</sup>	Screw terminal connection	Plastic	Aluminum	•
6904717 ③	B4151-0/9	Female	Straight	5	6.0...8.0 mm	0.14...1.5 mm <sup>2</sup>	Screw terminal connection	Plastic	Die-cast zinc	•
6904718 ④	BS4151-0/9	Male	Straight	5	6.0...8.0 mm	0.14...1.5 mm <sup>2</sup>	Screw terminal connection	Plastic	Die-cast zinc	•
6901114 ⑤	B4231-0/9	Female	Angled	3	6.0...8.0 mm	0.14...1.5 mm <sup>2</sup>	Screw terminal connection	Plastic	Die-cast zinc	-
6901021 ⑤	B4241-0/9	Female	Angled	4	6.0...8.0 mm	0.14...1.5 mm <sup>2</sup>	Screw terminal connection	Plastic	Die-cast zinc	-
6901113 ⑤	B4251-0/9	Female	Angled	5	6.0...8.0 mm	0.14...1.5 mm <sup>2</sup>	Screw terminal connection	Plastic	Die-cast zinc	•
6933448 ⑥	BS4231-0/9	Male	Angled	3	6.0...8.0 mm	0.14...1.5 mm <sup>2</sup>	Screw terminal connection	Plastic	Die-cast zinc	-
6901020 ⑥	BS4241-0/9	Male	Angled	4	6.0...8.0 mm	0.14...1.5 mm <sup>2</sup>	Screw terminal connection	Plastic	Die-cast zinc	-
6901112 ⑥	BS4251-0/9	Male	Angled	5	6.0...8.0 mm	0.14...1.5 mm <sup>2</sup>	Screw terminal connection	Plastic	Die-cast zinc	•
6914526 ③	B4151-0/11	Female	Straight	5	8.0...10.0 mm	0.14...1.5 mm <sup>2</sup>	Screw terminal connection	Plastic	Aluminum	•
6914511 ①	B4131-0/11	Female	Straight	3	8.0...10.0 mm	0.14...1.0 mm <sup>2</sup>	Screw terminal connection	Plastic	Aluminum	-
6914512 ①	B4141-0/11	Female	Straight	4	8.0...10.0 mm	0.14...1.0 mm <sup>2</sup>	Screw terminal connection	Plastic	Aluminum	-
6932844 ①	B4152-0/11	Female	Straight	5	8.0...10.0 mm	0.14...1.0 mm <sup>2</sup>	Screw terminal connection	Plastic	Aluminum	-
6914518 ②	BS4141-0/11	Male	Straight	4	8.0...10.0 mm	0.14...1.0 mm <sup>2</sup>	Screw terminal connection	Plastic	Aluminum	-
6914507 ②	BS4151-0/11	Male	Straight	5	8.0...10.0 mm	0.14...1.0 mm <sup>2</sup>	Screw terminal connection	Plastic	Aluminum	•
6904720 ③	B4131-0/13.5	Female	Straight	3	10.0...12.0 mm	0.14...1.0 mm <sup>2</sup>	Screw terminal connection	Plastic	Die-cast zinc	-
6904715 ③	B4151-0/13.5	Female	Straight	5	10.0...12.0 mm	0.14...1.0 mm <sup>2</sup>	Screw terminal connection	Plastic	Die-cast zinc	•
6904719 ④	BS4131-0/13.5	Male	Straight	3	10.0...12.0 mm	0.14...1.0 mm <sup>2</sup>	Screw terminal connection	Plastic	Die-cast zinc	-
6904716 ④	BS4151-0/13.5	Male	Straight	5	10.0...12.0 mm	0.14...1.0 mm <sup>2</sup>	Screw terminal connection	Plastic	Die-cast zinc	•
6914509 ①	B4141-0/13.5	Female	Straight	4	10.0...12.0 mm	0.14...1.0 mm <sup>2</sup>	Screw terminal connection	Plastic	Aluminum	•
6914510 ②	BS4141-0/13.5	Male	Straight	4	10.0...12.0 mm	0.14...1.0 mm <sup>2</sup>	Screw terminal connection	Plastic	Aluminum	•
6914520 ①	B4151-0/16	Female	Straight	5	12.0...14.0 mm	0.14...1.5 mm <sup>2</sup>	Screw terminal connection	Plastic	Aluminum	•
6914519 ②	BS4151-0/16	Male	Straight	5	12.0...14.0 mm	0.14...1.5 mm <sup>2</sup>	Screw terminal connection	Plastic	Aluminum	•

# Sensor- and Actuator-Connection

M16

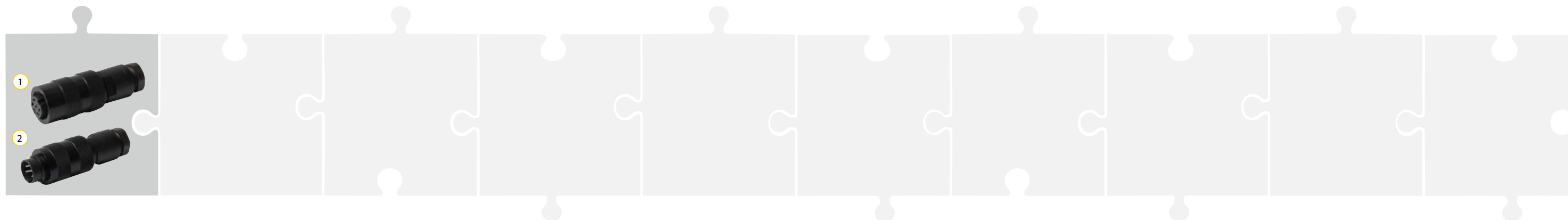

Ident-No.	Type Code	Gender	Design	Pins	Cable Feedthrough	Terminal Capacity	Connection	Housing	Coupling Nut	Availability
6934727 ①	BK4-0	Female	Straight	4	6.0...8.0 mm	0.14...0.75 mm <sup>2</sup>	Solder contact	Plastic	Die-cast zinc	-
6934729 ①	BK5-0	Female	Straight	5	6.0...8.0 mm	0.14...0.75 mm <sup>2</sup>	Solder contact	Plastic	Die-cast zinc	-
6934731 ①	BK6-0	Female	Straight	6	6.0...8.0 mm	0.14...0.75 mm <sup>2</sup>	Solder contact	Plastic	Die-cast zinc	-
6934733 ①	BK7-0	Female	Straight	7	6.0...8.0 mm	0.14 ... 0.75 mm <sup>2</sup>	Solder contact	Plastic	Die-cast zinc	-
6934736 ①	BK8-0	Female	Straight	8	6.0...8.0 mm	0.14...0.75 mm <sup>2</sup>	Solder contact	Plastic	Die-cast zinc	-
6934741 ①	BK12-0	Female	Straight	12	6.0...8.0 mm	0.14...0.25 mm <sup>2</sup>	Solder contact	Plastic	Die-cast zinc	-
6934765 ①	BK14-0	Female	Straight	14	6.0...8.0 mm	0.14...0.25 mm <sup>2</sup>	Solder contact	Plastic	Die-cast zinc	-
6934742 ①	BK16-0	Female	Straight	16	6.0...8.0 mm	0.14...0.25 mm <sup>2</sup>	Solder contact	Plastic	Die-cast zinc	-
6934766 ①	BK19-0	Female	Straight	19	6.0...8.0 mm	0.14...0.25 mm <sup>2</sup>	Solder contact	Plastic	Die-cast zinc	-
6934728 ②	BS4-0	Male	Straight	4	6.0...8.0 mm	0.14...0.75 mm <sup>2</sup>	Solder contact	Plastic	Die-cast zinc	-
6934730 ②	BS5-0	Male	Straight	5	6.0...8.0 mm	0.14...0.75 mm <sup>2</sup>	Solder contact	Plastic	Die-cast zinc	-
6934732 ②	BS6-0	Male	Straight	6	6.0...8.0 mm	0.14...0.75 mm <sup>2</sup>	Solder contact	Plastic	Die-cast zinc	-
6934734 ②	BS7-0	Male	Straight	7	6.0...8.0 mm	0.14...0.75 mm <sup>2</sup>	Solder contact	Plastic	Die-cast zinc	-
6934737 ②	BS8-0	Male	Straight	8	6.0...8.0 mm	0.14...0.75 mm <sup>2</sup>	Solder contact	Plastic	Die-cast zinc	-
6934767 ②	BS12-0	Male	Straight	12	6.0...8.0 mm	0.14...0.25 mm <sup>2</sup>	Solder contact	Plastic	Die-cast zinc	-
6934743 ②	BS14-0	Male	Straight	14	6.0...8.0 mm	0.14...0.25 mm <sup>2</sup>	Solder contact	Plastic	Die-cast zinc	-
6934744 ②	BS16-0	Male	Straight	16	6.0...8.0 mm	0.14...0.25 mm <sup>2</sup>	Solder contact	Plastic	Die-cast zinc	-
6934745 ②	BS19-0	Male	Straight	19	6.0...8.0 mm	0.14...0.25 mm <sup>2</sup>	Solder contact	Plastic	Die-cast zinc	-

# Sensor- and Actuator-Connection

M23



Ident-No.	Type Code	Gender	Design	Pins	Cable Feedthrough	Terminal Capacity	Connection	Housing	Coupling Nut	Availability
6604093 ①	FW-M23ST12Q-G-CP-ME-XX-10	Male	Straight	12	6.0...8.0 mm	0.25...1.0 mm <sup>2</sup>	Crimp contact	Brass	Brass	–
6604070 ①	FW-M23ST12Q-G-LT-ME-XX-10	Male	Straight	12	6.0...8.0 mm	0.25...1.0 mm <sup>2</sup>	Solder contact	Brass	Brass	•
6604051 ①	FW-M23ST19Q-G-CP-ME-XX-10	Male	Straight	19	6.0...8.0 mm	0.25...1.0 mm <sup>2</sup>	Crimp contact	Brass	Brass	•
6604208 ①	FW-M23ST19Q-G-LT-ME-XX-10	Male	Straight	19	6.0...8.0 mm	0.25...1.0 mm <sup>2</sup>	Solder contact	Brass	Brass	–
6604069 ②	FW-M23KU170-G-CP-ME-SH-14.5	Female	Straight	17	7.7...14.5 mm	0.25...1.0 mm <sup>2</sup>	Crimp contact	Brass	Brass	•
6604067 ③	FW-M23ST17Q-G-CP-ME-SH-14.5	Male	Straight	17	7.7...14.5 mm	0.25...1.0 mm <sup>2</sup>	Crimp contact	Brass	Brass	•
6604066 ④	FW-M23KU170-W-CP-ME-SH-14.5	Female	Angled	17	7.7...14.5 mm	0.25...1.0 mm <sup>2</sup>	Crimp contact	Brass	Brass	–
6604068 ⑤	FW-M23ST17Q-W-CP-ME-SH-14.5	Male	Angled	17	7.7...14.5 mm	0.25...1.0 mm <sup>2</sup>	Crimp contact	Brass	Brass	–

# Valve Connector

Valve Connector



Ident-No.	Type Code	Gender	Design	Pins	Cable Feedthrough	Terminal Capacity	Connection	Housing	Coupling Nut	Availability
8028723 ①	VC-AC21-0.220-K	Male	Design A	2+PE	6.0...8.0 mm	0.25...1.0 mm <sup>2</sup>	Screw terminal connection	Plastic	-	•
8028728 ②	VC-AC21-11.024-K	Male	Design A	2+PE	6.0...8.0 mm	0.25...1.0 mm <sup>2</sup>	Screw terminal connection	Plastic	-	•
8031583 ①	VC-AC31-0.220-K	Male	Design A	3+PE	6.0...8.0 mm	0.25...1.0 mm <sup>2</sup>	Screw terminal connection	Plastic	-	-
8031584 ②	VC-AC31-11.024-K	Male	Design A	3+PE	6.0...8.0 mm	0.25...1.0 mm <sup>2</sup>	Screw terminal connection	Plastic	-	-
8028724 ③	VC-BC21-0.220-K	Male	Design B	2+PE	6.0...8.0 mm	0.25...1.0 mm <sup>2</sup>	Screw terminal connection	Plastic	-	•
8028729 ④	VC-BC21-11.024-K	Male	Design B	2+PE	6.0...8.0 mm	0.25...1.0 mm <sup>2</sup>	Screw terminal connection	Plastic	-	-
8028725 ⑤	VC-IC21-0.220-K	Male	Design BI	2+PE	6.0...8.0 mm	0.25...1.0 mm <sup>2</sup>	Screw terminal connection	Plastic	-	-
8028730 ④	VC-IC21-11.024-K	Male	Design BI	2+PE	6.0...8.0 mm	0.25...1.0 mm <sup>2</sup>	Screw terminal connection	Plastic	-	•
8028726 ⑤	VC-CC8.21-0.220-K	Male	Design C	2+PE	4.0...6.0 mm	0.14...0.34 mm <sup>2</sup>	Screw terminal connection	Plastic	-	•
8028731 ⑥	VC-CC8.21-11.024-K	Male	Design C	2+PE	4.0...6.0 mm	0.14...0.34 mm <sup>2</sup>	Screw terminal connection	Plastic	-	-
8028727 ⑤	VC-CC9.21-0.220-K	Male	Design CI	2+PE	4.0...6.0 mm	0.14...0.34 mm <sup>2</sup>	Screw terminal connection	Plastic	-	-
8028732 ⑥	VC-CC9.21-11.024-K	Male	Design CI	2+PE	4.0...6.0 mm	0.14...0.34 mm <sup>2</sup>	Screw terminal connection	Plastic	-	-

# PROFIBUS-DP

M12, B-coded



Ident-No.	Type Code	Gender	Design	Pins	Cable Feedthrough	Terminal Capacity	Connection	Housing	Coupling Nut	Availability
6904721 ①	BMWS8151-8.5	Female	Straight	5	6.0...8.5 mm	0.14...0.75 mm <sup>2</sup>	Screw terminal connection	Die-cast zinc	Die-cast zinc	•
6904722 ②	BMSWS8151-8.5	Male	Straight	5	6.0...8.5 mm	0.14...0.75 mm <sup>2</sup>	Screw terminal connection	Die-cast zinc	Die-cast zinc	•
6904723 ③	BMWS8251-8.5	Female	Angled	5	6.0...8.5 mm	0.14...0.75 mm <sup>2</sup>	Screw terminal connection	Die-cast zinc	Die-cast zinc	•
6904724 ④	BMSWS8251-8.5	Male	Angled	5	6.0...8.5 mm	0.14...0.75 mm <sup>2</sup>	Screw terminal connection	Die-cast zinc	Die-cast zinc	•
6604210 ①	FW-M12KU5W-G-ZF-ME-SH-9	Female	Straight	5	7.0...9.0 mm	0.14...0.75 mm <sup>2</sup>	Screw terminal connection	Die-cast zinc	Die-cast zinc	•
6604211 ②	FW-M12ST5W-G-ZF-ME-SH-9	Male	Straight	5	7.0...9.0 mm	0.14...0.75 mm <sup>2</sup>	Screw terminal connection	Die-cast zinc	Die-cast zinc	•

Sub-D

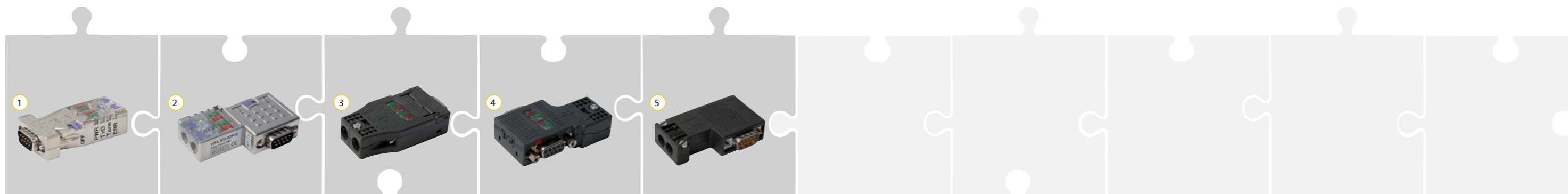

Ident-No.	Type Code	Gender	Design	Pins	Cable Feedthrough	Terminal Capacity	Connection	Housing	Coupling Nut	Availability
6604221 ①	FW-D9TLEDKU9XX-G-FC-ME-SH-8.5	Male	Straight	9	6.0...8.0 mm	-	IDC	Die-cast zinc	-	•
6604220 ②	FW-D9TLEDKU9PG-W-FC-ME-SH-8.5	Male	Angled	9	6.0...8.0 mm	-	IDC	Die-cast zinc	-	•
6780088 ③	6GK1500-0FC10	Male	Straight	9	6.0...8.0 mm	-	IDC	Plastic	-	-
6780101 ④	6ES7972-0BB52-0XA0-IP20FC-PG	Male	Angled	9	6.0...8.0 mm	-	IDC	Plastic	-	-
6780102 ⑤	6ES7972-0BB52-0XA0-IP20FC	Male	Angled	9	6.0...8.0 mm	-	IDC	Plastic	-	-



# CAN/DeviceNet™

M12, A-coded

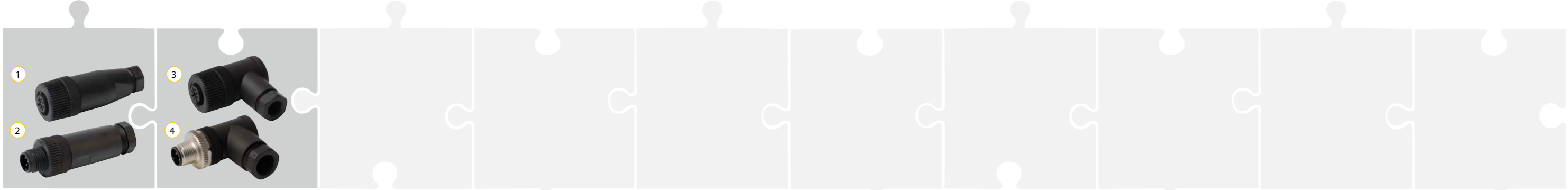

Ident-No.	Type Code	Gender	Design	Pins	Cable Feedthrough	Terminal Capacity	Connection	Housing	Coupling Nut	Availability
6904604 ①	B8151-0/9	Female	Straight	5	6.0...8.0 mm	0.14...0.75 mm <sup>2</sup>	Screw terminal connection	Plastic	Plastic	•
6904613 ②	BS8151-0/9	Male	Straight	5	6.0...8.0 mm	0.14...0.75 mm <sup>2</sup>	Screw terminal connection	Plastic	Plastic	•
6904603 ③	B8251-0/9	Female	Angled	5	6.0...8.0 mm	0.14...0.75 mm <sup>2</sup>	Screw terminal connection	Plastic	Plastic	•
6904615 ④	BS8251-0/9	Male	Angled	5	6.0...8.0 mm	0.14...0.75 mm <sup>2</sup>	Screw terminal connection	Plastic	Die-cast zinc	•

7/8"

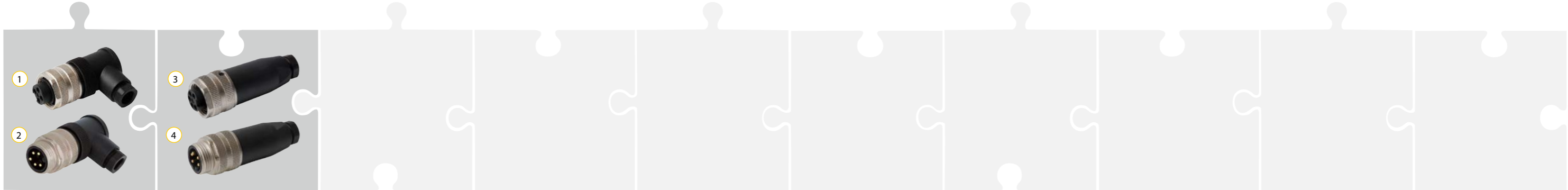

Ident-No.	Type Code	Gender	Design	Pins	Cable Feedthrough	Terminal Capacity	Connection	Housing	Coupling Nut	Availability
6901113 ①	B4251-0/9	Female	Angled	5	6.0...8.0 mm	0.14...1.5 mm <sup>2</sup>	Screw terminal connection	Plastic	Die-cast zinc	•
6901112 ②	BS4251-0/9	Male	Angled	5	6.0...8.0 mm	0.14...1.5 mm <sup>2</sup>	Screw terminal connection	Plastic	Die-cast zinc	•
6904717 ③	B4151-0/9	Female	Straight	5	6.0...8.0 mm	0.14...1.5 mm <sup>2</sup>	Screw terminal connection	Plastic	Die-cast zinc	•
6904718 ④	BS4151-0/9	Male	Straight	5	6.0...8.0 mm	0.14...1.5 mm <sup>2</sup>	Screw terminal connection	Plastic	Die-cast zinc	•
6904715 ③	B4151-0/13.5	Female	Straight	5	10.0...12.0 mm	0.14...1.0 mm <sup>2</sup>	Screw terminal connection	Plastic	Die-cast zinc	•
6904716 ④	BS4151-0/13.5	Male	Straight	5	10.0...12.0 mm	0.14...1.0 mm <sup>2</sup>	Screw terminal connection	Plastic	Die-cast zinc	•

# Ethernet

M8, A-coded – M12, D-coded

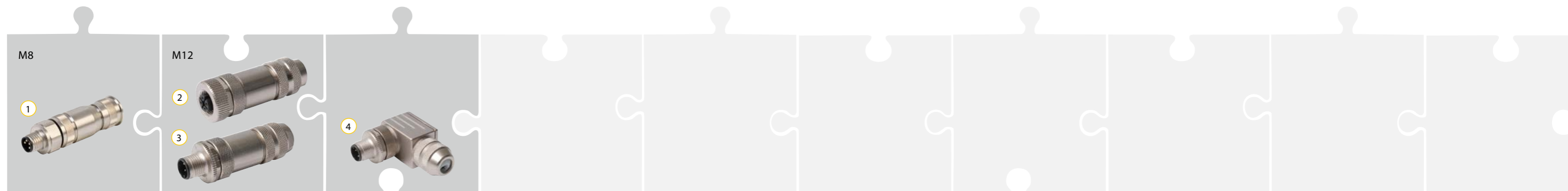

Ident-No.	Type Code	Gender	Design	Pins	Cable Feedthrough	Terminal Capacity	Connection	Housing	Coupling Nut	Availability
6935010 ①	FW-M8ST4-G-SB-ME-SH-6.5	Male	Straight	4	5.0...6.5 mm	0.14...0.5 mm <sup>2</sup>	Screw terminal connection	Brass	Brass	•
6604219 ②	FW-M12KU5D-G-SB-ME-SH-8	Female	Straight	4	5.0...8.0 mm	0.14...0.75 mm <sup>2</sup>	Screw terminal connection	Die-cast zinc	Die-cast zinc	•
6604218 ③	FW-M12ST5D-G-SB-ME-SH-8	Male	Straight	4	5.0...8.0 mm	0.14...0.75 mm <sup>2</sup>	Screw terminal connection	Die-cast zinc	Die-cast zinc	•
6604282 ③	CMBSD8141-0/PG9	Male	Straight	4	6.0...8.0 mm	0.14...0.75 mm <sup>2</sup>	Screw terminal connection	Die-cast zinc	Die-cast zinc	•
6604239 ④	CMBSD8241-0/PG9	Male	Angled	4	6.0...8.0 mm	0.14...0.75 mm <sup>2</sup>	Screw terminal connection	Die-cast zinc	Die-cast zinc	–
6930792 ③	CMBS8181-0	Male	Straight	8	6.0...8.0 mm	0.14...0.5 mm <sup>2</sup>	Screw terminal connection	Die-cast zinc	Die-cast zinc	•

## RJ45

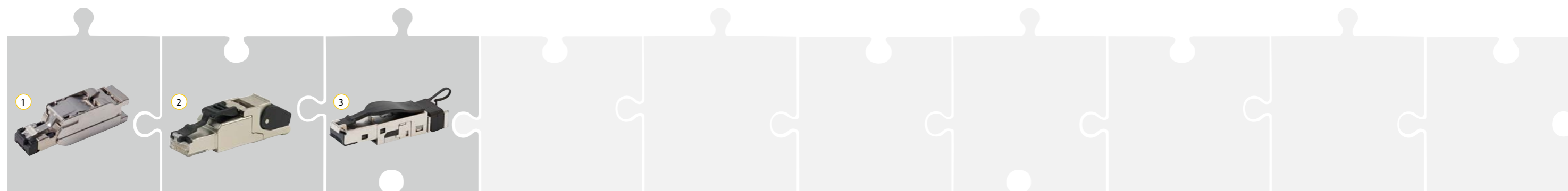

Ident-No.	Type Code	Gender	Design	Pins	Cable Feedthrough	Terminal Capacity	Connection	Housing	Coupling Nut	Availability
6780031 ①	6GK1901-1BB10-2AA0/FC-RJ45	Male	Straight	4	6.0...8.0 mm	–	IDC	Metal	–	•
6932658 ②	CONNECTOR-FW-RJ45S-84-IDC	Male	Straight	8	5.5...9.0 mm	0.14...0.34 mm <sup>2</sup>	IDC	Die-cast zinc	–	•
6935058 ③	CONNECTOR-FW-RJ45S-86-IDC-CAT-6	Male	Straight	8	5.5...8.5 mm	0.14...0.34 mm <sup>2</sup>	IDC	Die-cast zinc	–	–

# FOUNDATION™ fieldbus , PROFIBUS-PA

M12, A-coded



Ident-No.	Type Code	Gender	Design	Pins	Cable Feedthrough	Terminal Capacity	Connection	Housing	Coupling Nut	Availability
6904702 ①	BMS8141-0/9	Female	Straight	4	4.0...9.0 mm	0.14...0.75 mm <sup>2</sup>	Screw terminal connection	Die-cast zinc	Brass	•
6904701 ②	BMSS8141-0/9	Male	Straight	4	4.0...9.0 mm	0.14...0.75 mm <sup>2</sup>	Screw terminal connection	Die-cast zinc	Brass	•
6914538 ③	BKV8140-0/9	Female	Straight	4	4.0...8.0 mm	0.14...0.75 mm <sup>2</sup>	Screw terminal connection	Plastic	Stainless steel	•
6914537 ④	BSV8140-0/9	Male	Straight	4	4.0...8.0 mm	0.14...0.75 mm <sup>2</sup>	Screw terminal connection	Plastic	Stainless steel	•
6914540 ⑤	BKV8240-0/9	Female	Angled	4	4.0...8.0 mm	0.14...0.75 mm <sup>2</sup>	Screw terminal connection	Plastic	Stainless steel	•
6914539 ⑥	BSV8240-0/9	Male	Angled	4	4.0...8.0 mm	0.14...0.75 mm <sup>2</sup>	Screw terminal connection	Plastic	Stainless steel	•

# AIDA

M12 Safety, A-coded

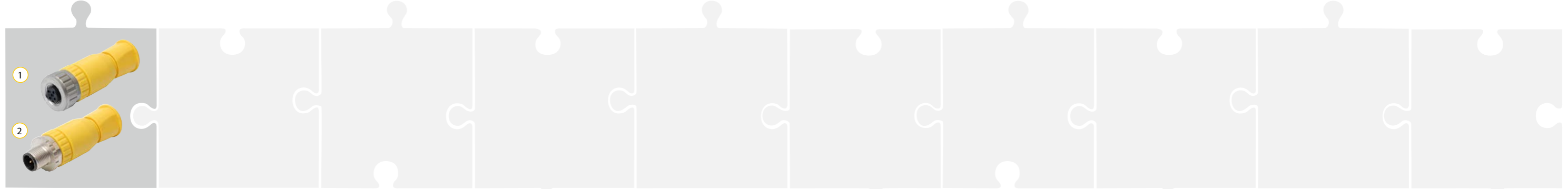

Ident-No.	Type Code	Gender	Design	Pins	Cable Feedthrough	Terminal Capacity	Connection	Housing	Coupling Nut	Availability
6936233	BM8151-0/PG9/YE	Female	Straight	5	4.0...8.0 mm	0.25...1.5 mm <sup>2</sup>	Screw terminal connection	Plastic	Die-cast zinc	•
6936232	BMS8151-0/PG9/YE	Male	Straight	5	4.0...8.0 mm	0.25...1.5 mm <sup>2</sup>	Screw terminal connection	Plastic	Die-cast zinc	•

RJ45 Push Pull

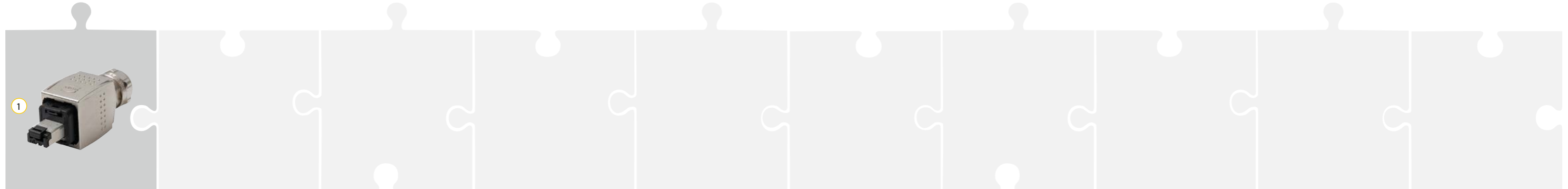

Ident-No.	Type Code	Gender	Design	Pins	Cable Feedthrough	Terminal Capacity	Connection	Housing	Coupling Nut	Availability
6935631	AIDA-RJ45-CC	Male	Straight	4	4.0...11.0 mm	0.14...0.34 mm <sup>2</sup>	IDC	Die-cast zinc	-	•

Power Push Pull

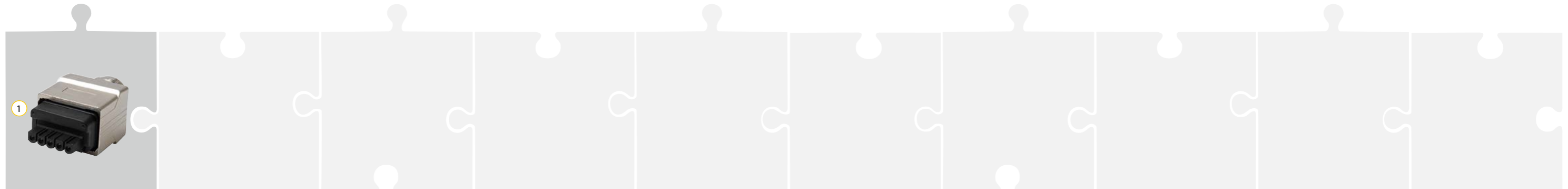

Ident-No.	Type Code	Gender	Design	Pins	Cable Feedthrough	Terminal Capacity	Connection	Housing	Coupling Nut	Availability
6935632	AIDA-POWER-CC	Male	Straight	5	9.0...13.0 mm	-	Tension spring connection	Die-cast zinc	-	•

# Power Supply

7/8"



Ident-No.	Type Code	Gender	Design	Pins	Cable Feedthrough	Terminal Capacity	Connection	Housing	Coupling Nut	Availability
6904717 ①	B4151-0/9	Female	Straight	5	6.0...8.0 mm	0.14...1.5 mm <sup>2</sup>	Screw terminal connection	Plastic	Die-cast zinc	•
6904718 ②	BS4151-0/9	Male	Straight	5	6.0...8.0 mm	0.14...1.5 mm <sup>2</sup>	Screw terminal connection	Plastic	Die-cast zinc	•
6901113 ③	B4251-0/9	Female	Angled	5	6.0...8.0 mm	0.14...1.5 mm <sup>2</sup>	Screw terminal connection	Plastic	Die-cast zinc	•
6901112 ④	BS4251-0/9	Male	Angled	5	6.0...8.0 mm	0.14...1.5 mm <sup>2</sup>	Screw terminal connection	Plastic	Die-cast zinc	•
6914551 ⑤	BK4140-0/9	Female	Straight	4	6.0...8.0 mm	0.14...1.0 mm <sup>2</sup>	Screw terminal connection	Plastic	Aluminum	•
6914550 ⑥	BS4140-0/9	Male	Straight	4	6.0...8.0 mm	0.14...1.0 mm <sup>2</sup>	Screw terminal connection	Plastic	Aluminum	•

M16



Ident-No.	Type Code	Gender	Design	Pins	Cable Feedthrough	Terminal Capacity	Connection	Housing	Coupling Nut	Availability
6934727 ①	BK4-0	Female	Straight	4	6.0...8.0 mm	0.14...0.75 mm <sup>2</sup>	Solder contact	Plastic	Die-cast zinc	-
6934729 ①	BK5-0	Female	Straight	5	6.0...8.0 mm	0.14...0.75 mm <sup>2</sup>	Solder contact	Plastic	Die-cast zinc	-
6934731 ①	BK6-0	Female	Straight	6	6.0...8.0 mm	0.14...0.75 mm <sup>2</sup>	Solder contact	Plastic	Die-cast zinc	-
6934728 ②	BS4-0	Male	Straight	4	6.0...8.0 mm	0.14...0.75 mm <sup>2</sup>	Solder contact	Plastic	Die-cast zinc	-
6934730 ②	BS5-0	Male	Straight	5	6.0...8.0 mm	0.14...0.75 mm <sup>2</sup>	Solder contact	Plastic	Die-cast zinc	-
6934732 ②	BS6-0	Male	Straight	6	6.0...8.0 mm	0.14...0.75 mm <sup>2</sup>	Solder contact	Plastic	Die-cast zinc	-



# TURCK

Over 30 subsidiaries and  
60 representations worldwide!

100000116 | 2018/04



[www.turck.com](http://www.turck.com)