

Your Global Automation Partner

TURCK

TX700

HMI/PLC Series

Instructions for Use



Table of Contents

1	About These Instructions	5
1.1	Target groups	5
1.2	Explanation of symbols used	5
1.3	Other documents	5
1.4	Feedback about these instructions	5
2	Notes on the Product	6
2.1	Product identification	6
2.1.1	Type label	6
2.1.2	Type code	7
2.2	Scope of delivery	7
2.3	Legal requirements	7
2.4	Manufacturer and service	8
3	For Your Safety	9
3.1	Intended use	9
3.2	General safety notes	9
3.3	Notes on Ex protection	9
3.4	Note on explosion protection (USA and Canada only)	9
3.5	Conditions resulting from ATEX and IECEx approval (use in Zone 2/Zone 22)	10
4	Product Description	11
4.1	Device overview	11
4.2	Properties and features	12
4.3	Functions and operating modes	13
4.3.1	Interfaces	13
4.4	Accessories	14
4.4.1	Plug-in extension modules	14
4.4.2	Power supply	14
4.4.3	USB accessory	14
5	Installing	15
5.1	Installation instructions	15
5.2	Fasten devices in the mounting cutout	16
5.3	Installing plug-in modules	17
5.4	Grounding the device	18
6	Connecting	19
6.1	Connecting TX705	19
6.2	Connecting TX707... TX721	20
6.3	Connecting the power supply	20
6.4	Connecting the device to Ethernet	21
6.5	Connecting external devices to the serial interface	21
6.6	Connecting plug-in modules	22
6.6.1	Slot assignment – CAN port	23
6.6.2	Slot assignment – serial interfaces	23
7	Commissioning	24
7.1	Charging the battery	24

7.2	Using the touchscreen.....	24
7.3	Initial commissioning	24
7.4	Web server login.....	24
7.5	Setting the IP address.....	25
7.5.1	Setting the IP address via the web server	25
7.5.2	Setting the IP address via Turck Service Tool	26
7.6	Programming with CODESYS.....	27
7.7	Programming with TX VisuPro	27
7.7.1	Transferring TX VisuPro to the device	27
8	Configuring.....	29
8.1	Configuring the system settings	29
9	Operating	31
9.1	LED displays.....	31
10	Troubleshooting	32
11	Maintenance.....	33
12	Repair	33
12.1	Returning devices.....	33
13	Disposal	33
14	Technical Data.....	34
15	Appendix: Approvals and markings	40

1 About These Instructions

These operating instructions describe the structure, functions and the use of the product and will help you to operate the product as intended. Read these instructions carefully before using the product. This is to avoid possible damage to persons, property or the device. Retain the instructions for future use during the service life of the product. If the product is passed on, pass on these instructions as well.

1.1 Target groups

These instructions are written for suitably qualified and trained personnel and must be read carefully by anyone entrusted with the mounting, commissioning, operation, maintenance, disassembly or disposal of the device.

When using the device in Ex circuits, the user must also have an additional knowledge of explosion protection (EN 60079-14 etc.).

1.2 Explanation of symbols used

The following symbols are used in these instructions:



DANGER

DANGER indicates a dangerous situation with high risk of death or severe injury if not avoided.



WARNING

WARNING indicates a dangerous situation with medium risk of death or severe injury if not avoided.



CAUTION

CAUTION indicates a dangerous situation of medium risk which may result in minor or moderate injury if not avoided.



NOTICE

NOTICE indicates a situation which may lead to property damage if not avoided.



NOTE

NOTE indicates tips, recommendations and useful information on specific actions and facts. The notes simplify your work and help you to avoid additional work.



CALL TO ACTION

This symbol denotes actions that the user must carry out.



RESULTS OF ACTION

This symbol denotes relevant results of actions.

1.3 Other documents

The following additional documents are available online at www.turck.com

- Data sheet
- Quick Start Guide

1.4 Feedback about these instructions

We make every effort to ensure that these instructions are as informative and as clear as possible. If you have any suggestions for improving the design or if some information is missing in the document, please send your suggestions to techdoc@turck.com.

2 Notes on the Product

2.1 Product identification

These instructions apply to the following HMIs:

- TX705-P3CV01
- TX707-P3CV01
- TX710-P3CV01
- TX715-P3CV01
- TX721-P3CV01
- TX707HB-P3CV01
- TX710HB-P3CV01

2.1.1 Type label

The Type label is located on the back of the device.

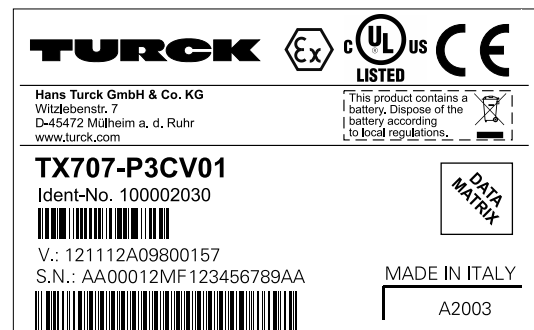
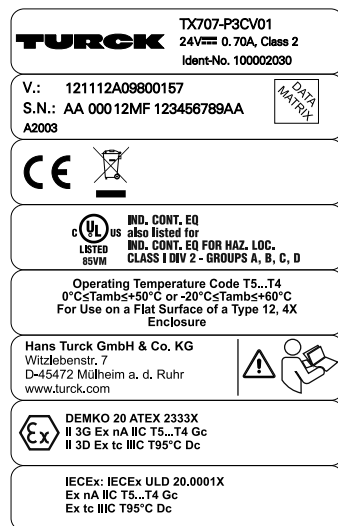

Fig. 1: Type label TX710 (example)

Type designation	TX707-...
Ident No.	100002031
Year/week of production	A2003
Serial number (S.N.)	AA...
Internal version ID of the product (V)	121...

2.1.2 Type code

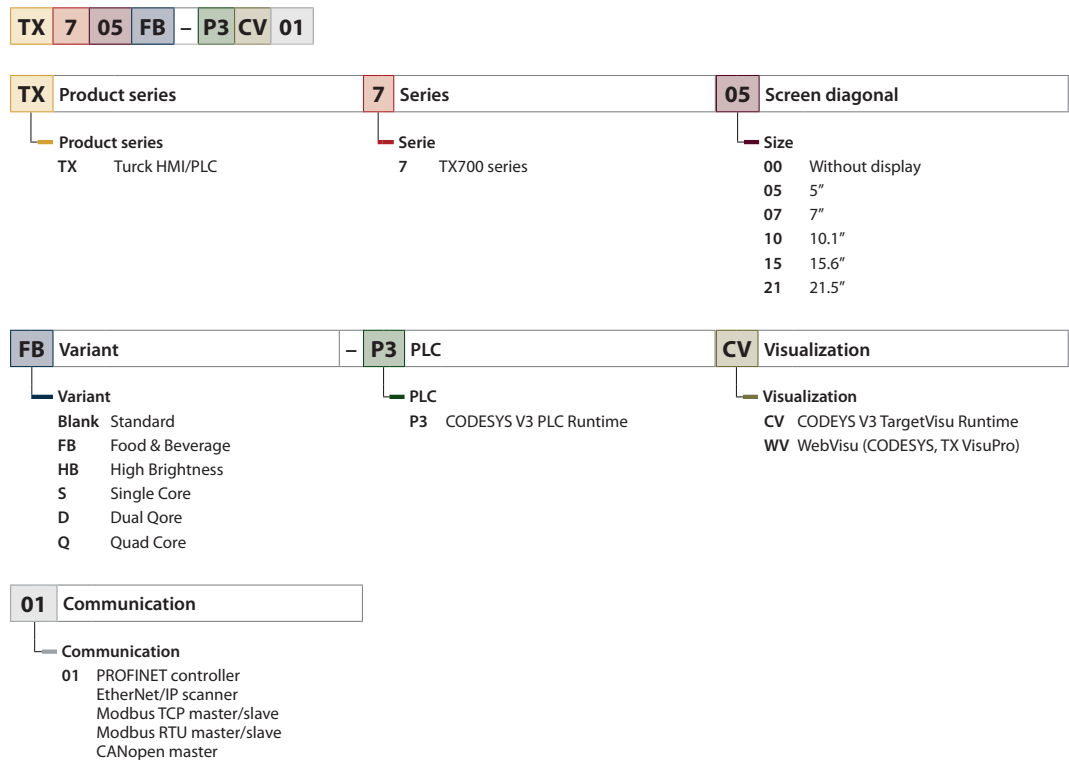

Fig. 2: Type code TX700

2.2 Scope of delivery

- TX700
- Power supply connector
- Connector for serial interface
- Mounting brackets
- Quick Start Guide

2.3 Legal requirements

The device is subject to the following EC directives:

- 2014/30/EU (electromagnetic compatibility)
- 2011/65/EU (RoHS Directive)
- 2014/34/EU (ATEX Directive)

2.4 Manufacturer and service

Hans Turck GmbH & Co. KG
Witzlebenstraße 7
45472 Mülheim an der Ruhr
Germany

Turck supports you with your projects, from initial analysis to the commissioning of your application. The Turck product database contains software tools for programming, configuration or commissioning, data sheets and CAD files in numerous export formats. You can access the product database at the following address: www.turck.de/products

For further inquiries in Germany contact the Sales and Service Team on:

- Sales: +49 208 4952-380
- Technology: +49 208 4952-390

Outside Germany, please contact your local Turck representative.

3 For Your Safety

The product is designed according to state-of-the-art technology. However, residual risks still exist. Observe the following warnings and safety notices to prevent damage to persons and property. Turck accepts no liability for damage caused by failure to observe these warning and safety notices.

3.1 Intended use

These devices are designed solely for use in industrial areas.

The HMIs (Human Machine Interfaces) of the TX700 family are used to control, operate and monitor machine processes. The TX700HB (High Brightness) variants are also suitable for use in full sunlight due to the nature of the display (higher contrast, increased brightness, reduced reflections and refraction, good sunlight readability).

The devices are suitable for use in Zone 2 and Zone 22.

The devices may only be used as described in these instructions. Any other use is not in accordance with the intended use. Turck accepts no liability for any resulting damage.

3.2 General safety notes

- The device may only be assembled, installed, operated, parameterized and maintained by professionally-trained personnel.
- The device may only be used in accordance with applicable national and international regulations, standards and laws.
- The device only meets the EMC requirements for industrial areas and is not suitable for use in residential areas.

3.3 Notes on Ex protection

- Observe national and international regulations for explosion protection.
- When using the device in explosion-protection circuits, the user must have a working knowledge of explosion protection (EN 60079-14 etc.).
- Use the device only within the permissible operating and ambient conditions (see approval data and Ex approval specifications).
- This device, with the exception of the front display, is an open device and must be installed in a housing suitable for the environment, so that the inner part of the device is only accessible by means of a tool.
- Do not disconnect device in an ignitable atmosphere when energized.
- Do not open the device under voltage.
- Do not remove Ethernet connections, USB devices and SD cards in an ignitable atmosphere.
- Do not remove the battery in an ignitable atmosphere.
- Switch-off the device before replacing or wiring extension modules.

3.4 Note on explosion protection (USA and Canada only)

- The device is suitable for the use in Class 1, Division 2, groups A, B, C and D hazardous locations or for the use in non-hazardous locations.
- The Power, input and output (I/O) wiring has to be done in accordance with Class I, Division 2 and in accordance with the authority having jurisdictions. For U.S. in accordance with Article 501.10 (B) of the National Electrical Code, NFPA 70 and for Canada in accordance with Section 18-1J2 of Canadian Electrical Code.
- Use only components that meet Class 1, Division 2 certification.
- Disconnect the device from the power supply before replacing or connecting plug-in modules.
- Do not disconnect the device in an ignitable atmosphere when energized.

3.5 Conditions resulting from ATEX and IECEx approval (use in Zone 2/Zone 22)

- Only use the device in an area of not more than pollution degree 2 as defined in IEC/EN 60664-1.
- Install the device in an enclosure with a protection class of at least IP54 in accordance with IEC/EN 60079-0.
- When used in Zone 22: Install the device in a housing of protection class IP6x in accordance with IEC/EN 60079-0.
- Only disconnect and connect circuits when no voltage is applied.
- Avoid layers of dust on the graphic panel which may cause the accumulation of static charges.
- Provide transient protection which is not exceeding 140 % of the peak rated voltage at the supply terminals to the equipment.

4 Product Description

The front of the device is designed in protection class IP66, the rear of the housing in IP20.

For the connection to Ethernet, two (TX705) or three (TX707...TX721) Ethernet ports are available.

The serial port is used to communicate with a PLC or with field devices with RS232 or RS485 interface. Plug-in modules with different functions (digital and analog I/Os, CAN master, PROFIBUS-DP slave, RS232 and RS485 interface, UMTS modem, etc.) can be connected via the extension slots. A USB host port and an SD card slot are provided for using external storage media.

The TFT widescreen color display of the devices is designed as a capacitive multi-touch touch screen.

Device variants:

- TX705: 5" HMI, CODESYS V3 PLC, WebVisu, single core A8 1 GHz, 2 Ethernet ports, 4 GB flash, 512 MB RAM
- TX707: 7" HMI, CODESYS V3 PLC, WebVisu, dual core A9, 800 MHz, 3 Ethernet ports, 4 GB Flash, 1 GB RAM
- TX707HB: 7"-HMI, high brightness display, CODESYS V3 PLC, WebVisu, dual core A9 800 MHz, 3 Ethernet ports, 4 GB flash, 1 GB RAM
- TX710: 10.1" HMI, CODESYS V3 PLC, WebVisu, dual core A9, 800 MHz, 3 Ethernet ports, 4 GB Flash, 1 GB RAM
- TX710HB: 10.1"-HMI, high brightness display, CODESYS V3 PLC, WebVisu, dual core A9 800 MHz, 3 Ethernet ports, 4 GB flash, 1 GB RAM
- TX715: 15.6" HMI, CODESYS V3 PLC, WebVisu quad core A9, 800 MHz, 3 Ethernet ports, 8 GB Flash, 2 GB RAM
- TX721: 21.5" HMI, CODESYS V3 PLC, WebVisu quad core A9, 800 MHz, 3 Ethernet ports, 8 GB Flash, 2 GB RAM

4.1 Device overview

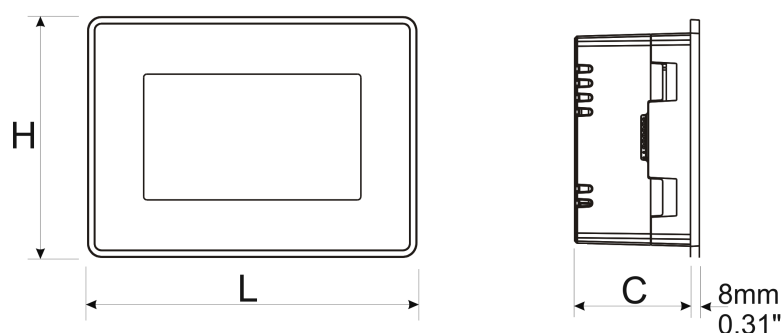

Fig. 3: Dimensions – TX705

Device	Height (H)	Width (L)	Depth (C)
TX705	107 mm/4.21"	147 mm/5.78"	56 mm/2.04"

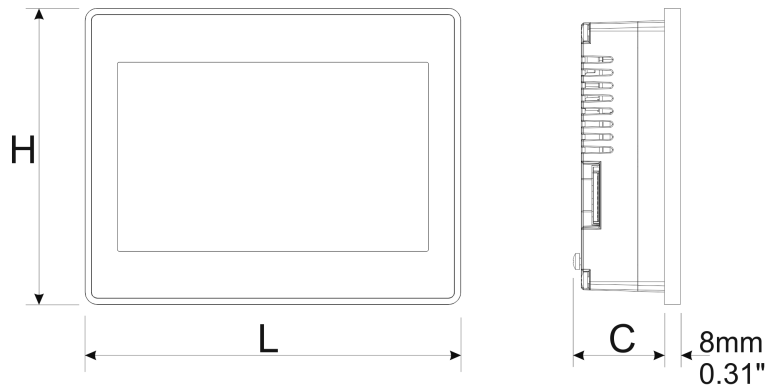

Fig. 4: Dimensions – TX707(HB)

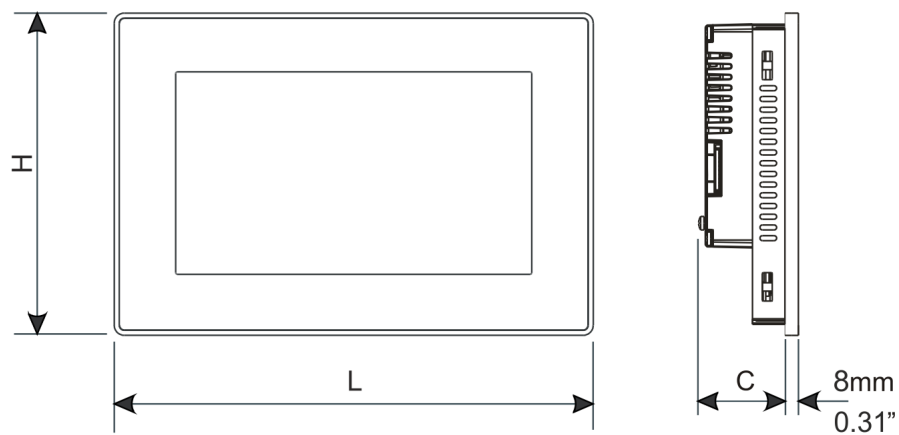

Fig. 5: Dimensions – TX710(HB), TX715, TX721

Device	Height (H)	Width (L)	Depth (C)
TX707(HB)	147 mm/5.79"	187 mm/7.36"	47 mm/1.85"
TX710(HB)	197 mm/7.80"	282 mm/11.10"	56 mm/2.20"
TX715	267 mm/10.50"	422 mm/16.60"	56 mm/2.20"
TX721	347 mm/13.66"	552 mm/21.73"	56 mm/2.20"

4.2 Properties and features

- Gateway function with OPC UA Server and Client (with TX VisuPro)
- Safe connection to Turck Cloud with complete network isolation
- MQTT for connecting all common cloud systems (with TX VisuPro)
- CODESYS V3 PLC runtime with selection of the most important I/O protocols
- CODESYS V3 WebVisu or TX VisuPro WebVisu
- Optional extension modules for I/Os and further communication interfaces

4.3 Functions and operating modes

The CODESYS V3 control of the devices has the functions PROFINET controller, EtherNet/IP scanner and Modbus TCP as well as Modbus RTU master. Additionally the TX700 HMIs can be used as Modbus TCP as well as Modbus RTU slave.

The devices combine all functions of a PLC with the functions and interfaces of the TX VisuPro software.

Additional functions

- Ethernet TCP/IP or UDP/IP communication
- OPC UA server (with CODESYS or TX VisuPro)
- OPC UA client and MQTT (with TX VisuPro)
- Serial communication via RS232, RS485 and RS422

4.3.1 Interfaces

The device has the following interfaces:

- Ethernet ports
 - TX705: 2 × 10/100 Mbit
 - TX707...TX721: 2 × 10/100 Mbit, 1 × 10/100/1000 Mbit
- Extension slots for plug-in modules
 - TX705: 1 slot for max. 2 plug-in modules
 - TX707...TX721: 2 slots for max. 4 plug-in modules
- Serial interface
- Slot for SD card
- USB port

Compatible SD cards

Specification	
Supported types	SD, SDHC
Format	FAT, FAT32
Max. size	Limited by FAT32 specifications ≤ 4 GB for a single file ≤ 32 GB

Compatible USB devices

Specification	
Format	FAT, FAT32
Max. size	Limited by FAT32 specifications ≤ 4 GB for a single file ≤ 32 GB

4.4 Accessories

4.4.1 Plug-in extension modules

Ident no.	Type	Description
6828210	TX-CAN	CAN interface
6828203	TX-IO-DX06	<ul style="list-style-type: none"> ■ 8 digital inputs, 24 VDC, pnp ■ 6 digital outputs, 24 VDC, 0.5 A, pnp ■ 1 × relay output, NO
6828201	TX-IO-XX03	<ul style="list-style-type: none"> ■ 20 digital inputs, 24 VDC, pnp ■ 12 digital outputs, 24 VDC, 0.5 A, pnp ■ 8 × analog inputs, U, I, RTD, TC ■ 4 × analog outputs, U, I
100002598	TX-RS485	Serial interface for RS485/RS422 communication
100002599	TX-RS232	Serial interface for RS232 communication
100004786	TX-EXTEND	Bus extension, electromechanical adapter for the use of the plug-in module TX-IO-XX03
100009535	TX-UMTS	Wireless modem plug-in (2G, 3G)
100010167	TX-DP-S	PROFIBUS-DP slave, 12 Mbaud

4.4.2 Power supply

Ident No.	Type	Description
100002938	TX-PSC	TX power supply onnector

4.4.3 USB accessory

Ident No.	Type	Description
6827389	USB 2.0 EXTENSION 5M	USB 2.0 extension cable, male (A) to female (A), 5 m
6827390	USB 2.0 EXTENSION ACTIVE 5M	USB 2.0 extension cable, male (A) to female (A), with active repeater, 5 m



NOTE

You will find further accessory products under www.turck.com.

5 Installing

The devices are inserted into a flat mounting plate with a corresponding installation cut-out.



NOTE

The technical data in the appendix of these operating instructions contain information on the size of the required installation cut-out.

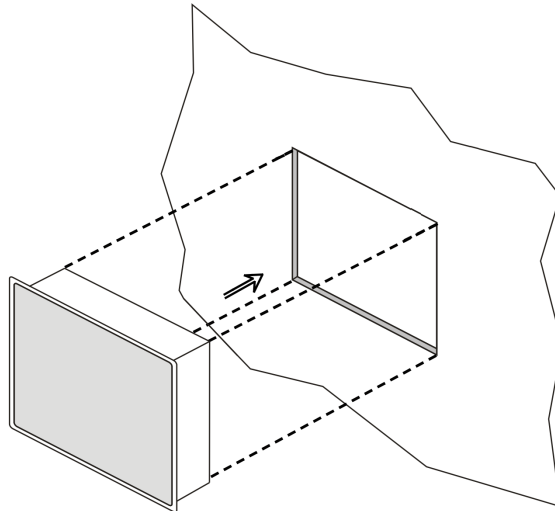

Fig. 6: TX700 – mounting

5.1 Installation instructions

- For use in Zone 2 and Zone 22: Observe notes on explosion protection.
- Do not cover the ventilation slots in the device.
- Do not expose the device to direct sunlight for long periods of time to avoid overheating the device.
- Do not install the device in environments in which it is exposed to corrosive chemical substances.

In order to meet the protection class IP66, the following installation procedure must be observed:

- The device is suitable for mounting on surfaces with a thickness of 1.5 mm to 6 mm.
- The maximum surface roughness of the mounting surface is 120 µm.
- The cut-out for the HMI must correspond to the specified dimensions, see "Technical Data".
- The borders of the cutout must be flat.
- The minimum tightening torque for the fixing screws of the mounting brackets is 130 Ncm. The mounting brackets must rest firmly on the device.

5.2 Fasten devices in the mounting cutout

The devices are fixed in the mounting cutout with mounting brackets.

- ▶ Mount the brackets as follows.

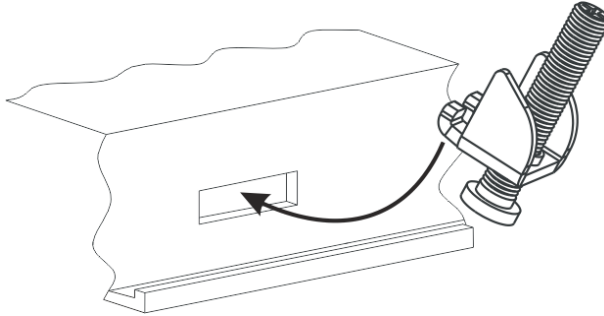

Fig. 7: Insert the brackets

- ▶ Tighten the fastening screws until the brackets are firmly in contact with the device. The minimum tightening torque to guarantee protection class IP66 is 130 Ncm.

5.3 Installing plug-in modules

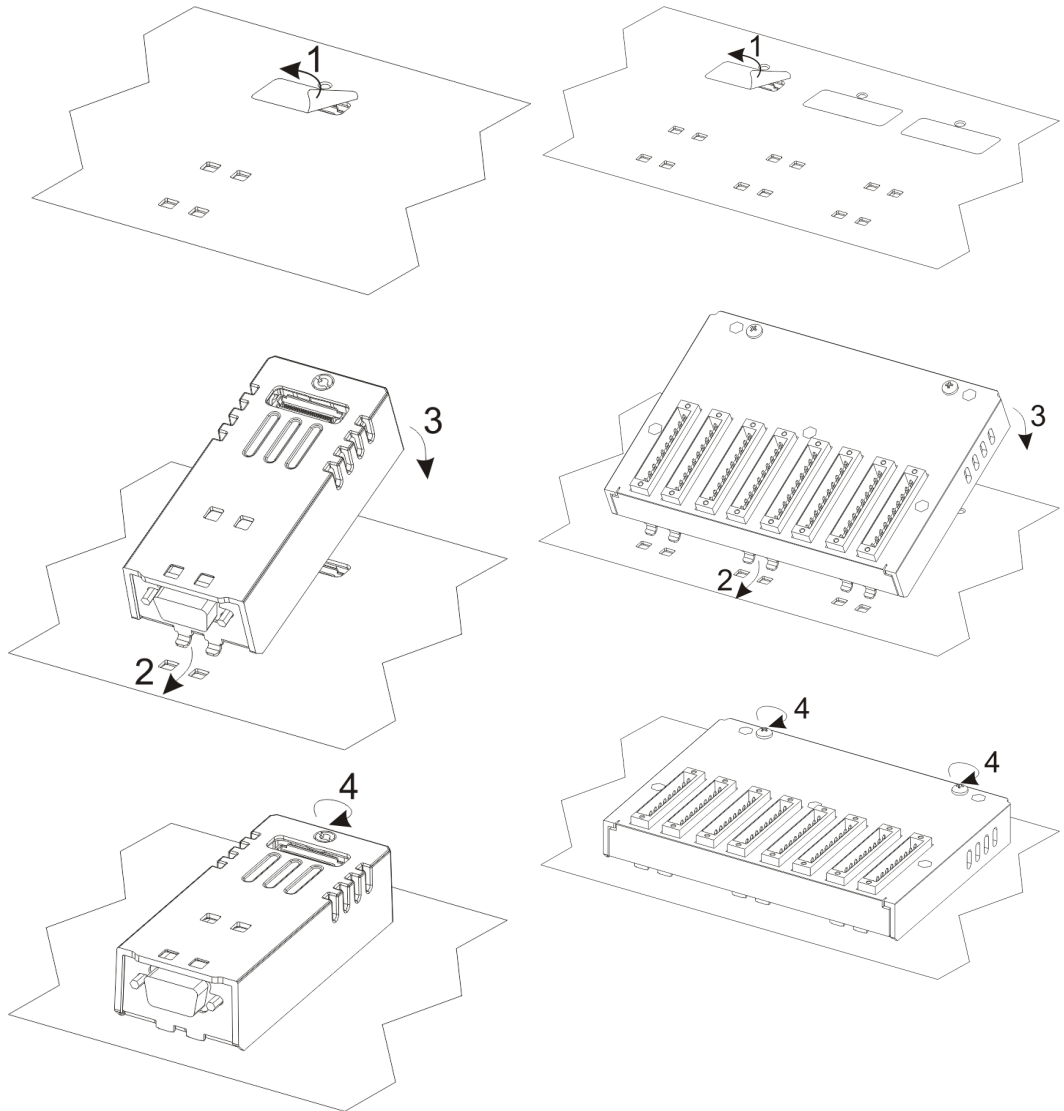

Fig. 8: Installing plug-in modules (e. g. TX-CAN, TX-IO-DX06)

Fig. 9: Installing plug-in modules (e. g. TX-IO-XX03)

5.4 Grounding the device

- ▶ Connect terminal 3 of the supply connector to the ground terminal.

General instructions for device grounding

- ▶ All the electronic devices in the control system must be properly grounded.
- ▶ Carry out grounding according to the applicable regulations.
- ▶ Ground the device to minimize noise effects from electromagnetic interference.
- ▶ Ground the unit via the grounding screw near the power supply connection.

Grounding the power supply

The power supply circuit may be floating or grounded.

- ▶ To ground the supply circuit, connect the ground wire to the protective earth as shown in the following figure (dotted line).
- ▶ If the supply circuit is not grounded, the unit itself is internally connected to ground (1 M Ω resistor with 4.7 nF capacitor connected in parallel).
- ▶ The power supply must have double or reinforced insulation.

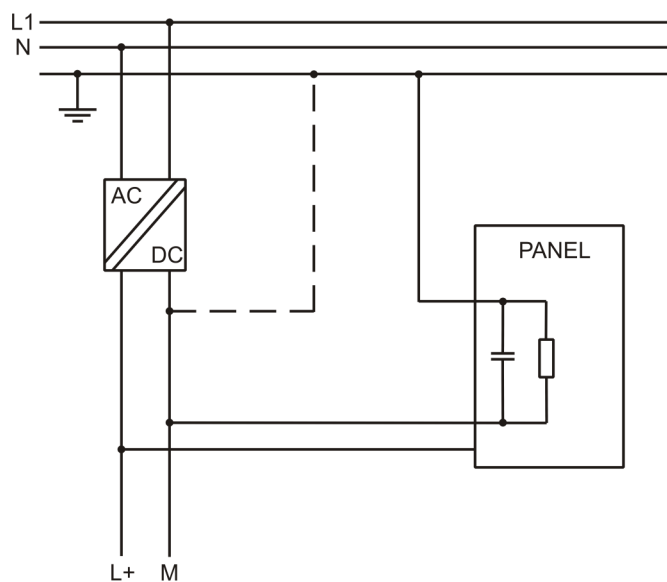

Fig. 10: Power supply – wiring

6 Connecting



DANGER

Ignitable atmosphere

Explosion by ignitable sparks

- ▶ Do not disconnect the device in an ignitable atmosphere when energized.
- ▶ Disconnect the device from the power supply before replacing or connecting modules.

- ▶ Observe notes on explosion protection.
- ▶ Provide transient protection at the supply terminals set to a maximum of 140 % of the peak value of the rated voltage.
- ▶ Ensure that the power supply is of sufficient capacity to operate the device.

6.1 Connecting TX705

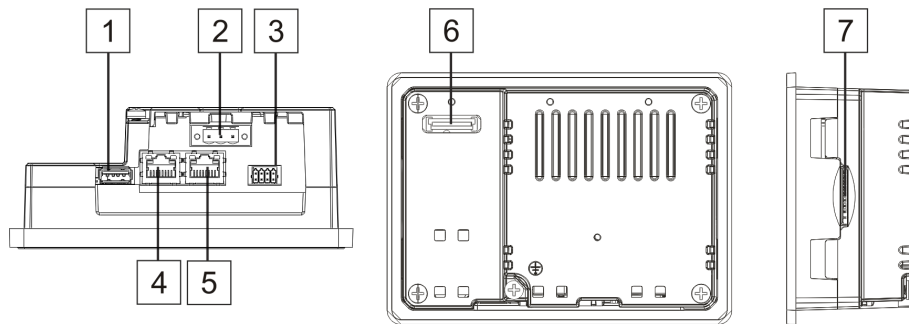

Fig. 11: TX705 – connectors

Port	Description
1	USB port , V2.0, max 500 mA (for maintenance only)
2	Power supply
3	Serial interface
4	Ethernet port 0 (10/100 Mbit)
5	Ethernet port 1 (10/100 Mbit)
6	Expansion slot for plug-in modules
7	SD card slot

6.2 Connecting TX707... TX721

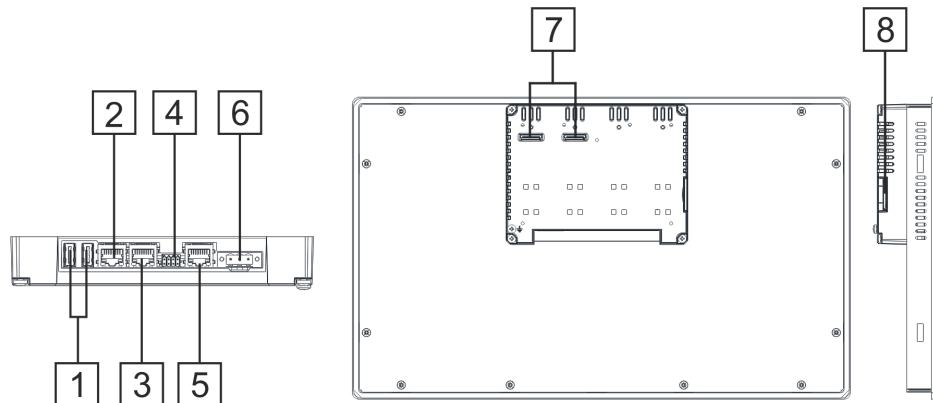

Fig. 12: TX707... TX721 – connectors

Port	Description
1	USB port, V2.0, max. 500 mA
2	Ethernet port 2 (10/100 Mbit)
3	Ethernet port 1 (10/100 Mbit)
4	Serial interface
5	Ethernet port 0 (10/100/1000 Mbit)
6	Power supply
7	2 extension slots for plug-in modules
8	SD card slot

6.3 Connecting the power supply



DANGER

Wrong selection of power supply

Danger to life due to overvoltage and electric shock!

- ▶ Only operate the device on SELV voltage sources according to the European standard or on Class 2 voltage sources according to the UL standard.

- ▶ Connect the device to the voltage supply according to the following figure.

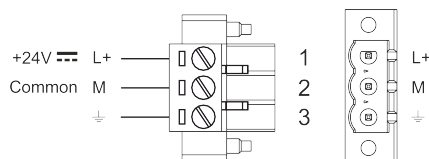

Fig. 13: Power connector TX7...



NOTE

The power connector is part of the scope of delivery and can be ordered as spare part [▶ 14].

6.4 Connecting the device to Ethernet

For the connection to Ethernet, the TX705 has two RJ45 Fast Ethernet sockets. The devices TX707...TX721 have two RJ45 Fast Ethernet sockets and one RJ45 Gigabit Ethernet socket.

- ▶ Connect the device to Ethernet using a standard Ethernet cable. Use a Gigabit-capable Ethernet cable to connect the devices to a Gigabit network.

Default settings of the Ethernet ports

The Ethernet ports are set to DHCP at delivery.

6.5 Connecting external devices to the serial interface

The serial port is used to communicate with a PLC or with another type of device. The following standards are available at the serial interface: The type of serial interface is determined in the programming software. The connection cable must be selected to match the device to be connected.

- RS232
- RS422
- RS485



Fig. 14: Serial interface

Pin	RS232	RS482/422
1	RxD	CHB-
2	TxD	CHA-
3	CTS	CHB+
4	RTS	CHA+
5	+5 VDC output	+5 VDC output
6	GND	GND
7	n. c.	n. c.
8	Shield	Shield



NOTE

To operate in RS485, pins 1 and 2 as well as pins 3 and 4 must be connected externally.

6.6 Connecting plug-in modules

The TX700 HMIs allow the use of several optional in modules. Several module configurations are possible.

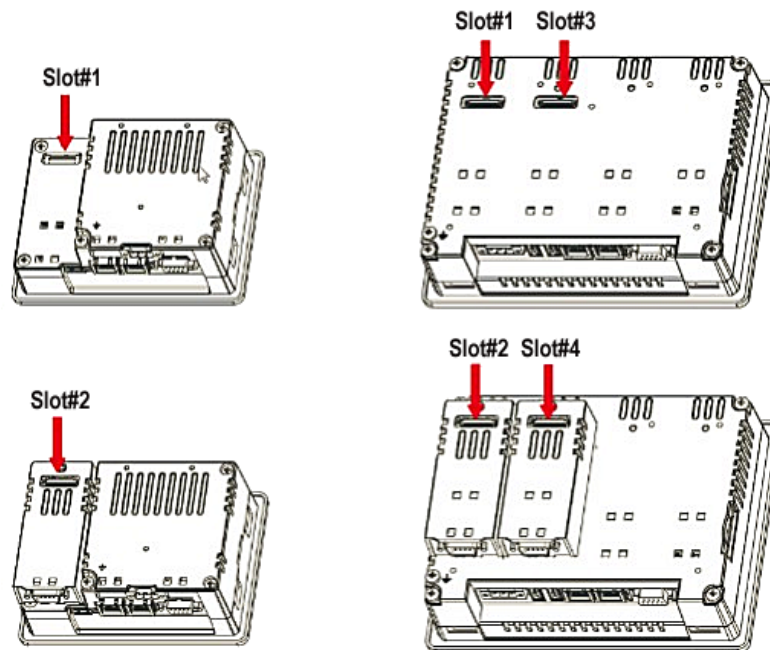

Fig. 15: Slots for plug-in modules

Slot 2 and slot 4 are available only if the plug-in module has bus extension connector.

Each slot has three communication channels:

- 1 serial interface
- 1 CAN interface
- 1 SPI interface



NOTE

It is not possible to stack two modules that are using the same type of interface.

The following table shows, which plug-in module and how many plug-in modules can be used at which device:

Module	Application	Max. number of modules	Interface type/ communication interface	Bus extension connector
TX-CAN	CAN	■ 1 for TX705	CAN	Yes
TX-RS485	RS485/RS422	■ 2 for TX707... TX721	Serial	Yes
TX-RS232	RS232		Serial	Yes
TX-IO-DX06	Compact I/O		SPI	No
TX-IO-XX03	Multifunction I/O	1	SPI	No

TX705: TX-EXTEND or other extension module with extension slot necessary

Module	Application	Max. number of modules	Interface type/ communication interface	Bus extension connector
TX-DP-S	PROFIBUS-DP slave	1	SPI	No
TX-UMTS	UMTS modem		Serial	Yes
TX-EXTEND	Extension module	1 for TX705	None	Yes

The column max. modules refers to the max. number of modules which can be plugged into the HMI (all slots).

6.6.1 Slot assignment – CAN port

Physical interface	CODESYS parameter „network“
Slot 1	Network 0
Slot 2	Network 0
Slot 3	Network 1
Slot 4	Network 1

6.6.2 Slot assignment – serial interfaces

Physical interface	CODESYS parameter “Device/In- terface Parameter”	CODESYS parameter “Modbus COM/COM Port”
local serial COM port	Mode COM1	COM Port 1
Slot 1	Mode COM2	COM Port 2
Slot 2	Mode COM2	COM Port 2
Slot 3	Mode COM3	COM Port 3
Slot 4	Mode COM3	COM Port 3

Slot 1 to Slot 4 refer to the extension slots on the rear of the device.

7 Commissioning



DANGER

Potentially explosive atmosphere

Explosion due to ignitable sparks in case of electrostatic discharge

- ▶ For use in zones 2 and 22: Clean the front of the device with a damp cloth before switching on to prevent electrostatic discharge.

7.1 Charging the battery

The device is equipped with a rechargeable lithium battery, which is not user replaceable.

The following information is maintained by the battery:

- Hardware real-time clock (date and time)

- ▶ Charge the battery for at least 48 hours before using the device for the first time.

When the battery is fully charged, it guarantees data backup at 25 °C for three months.

7.2 Using the touchscreen

- ▶ Before initial operation, check that the touch screen is working properly.
- ▶ Do not use sharp or pointed objects (screwdrivers, etc.) to operate the touch screen.

7.3 Initial commissioning

The Ethernet ports of the device are set to DHCP by default. During the initial commissioning, the IP address is therefore set via the system settings on the touch screen of the device, via a DHCP server in the network or via the Turck Service Tool.

7.4 Web server login

- ▶ Open the web server using the device's IP address.
- ▶ Connect via `https://IP`.
IP = current IP address of the TX... device
- ▶ Log on to the device as administrator:
Default user: admin
Default password: admin

If the simple link causes a conflict with an already active WebVisu application, the system settings can also be accessed directly via the following link:

`https://IP/machine_config`

Example access:

`https://192.168.1.24/machine_config`

Username: admin

Password: admin

7.5 Setting the IP address

The IP address can be set via the system settings on the touch screen of the device, the device's web server or via the Turck Service Tool.

7.5.1 Setting the IP address via the web server

- ▶ Log in to the device's web server as described under "Web server login".
- ▶ Edit the network setting via **System Settings** → **Network** → **Edit**.

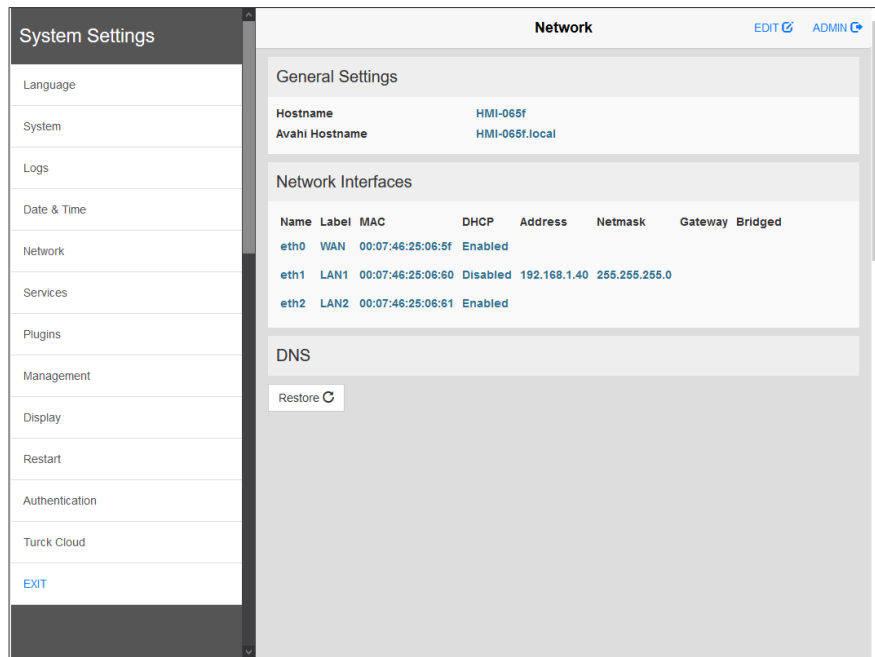

Fig. 16: Webserver – system settings

- ▶ Set the IP address, the subnet mask, etc. under **Network interface** and save the changes.

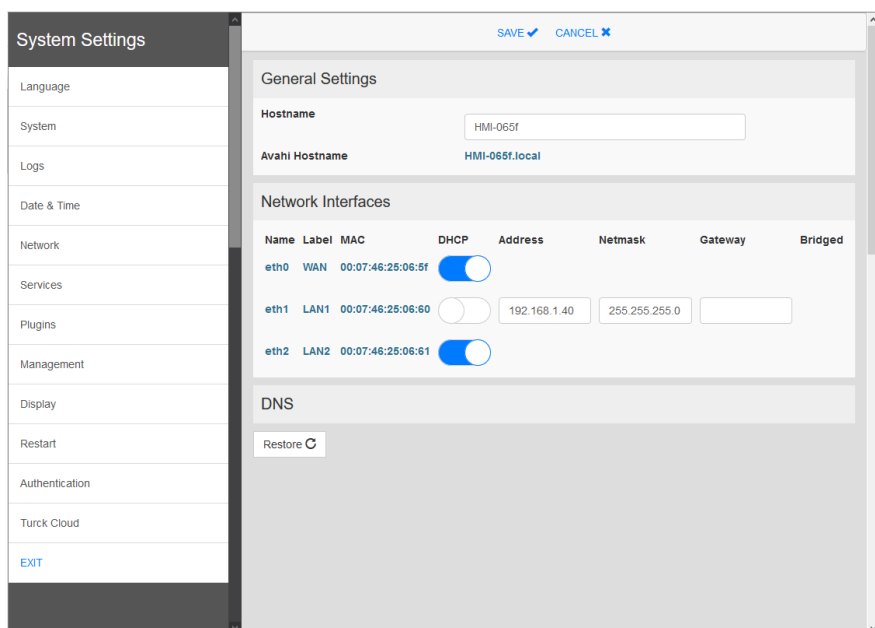

Fig. 17: Webserver – network interface

7.5.2 Setting the IP address via Turck Service Tool

- ▶ Connect the device to the PC via the Ethernet interface.
- ▶ Open Turck Service Tool.
- ▶ Click **Search** or press [F5].

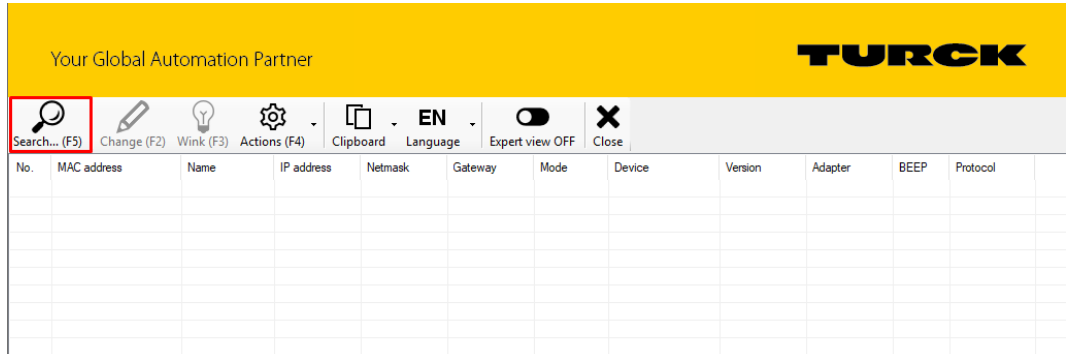

Fig. 18: Turck Service Tool – home screen

⇒ Turck Service Tool shows the connected devices.



NOTE

Clicking the device's IP address opens the web server.

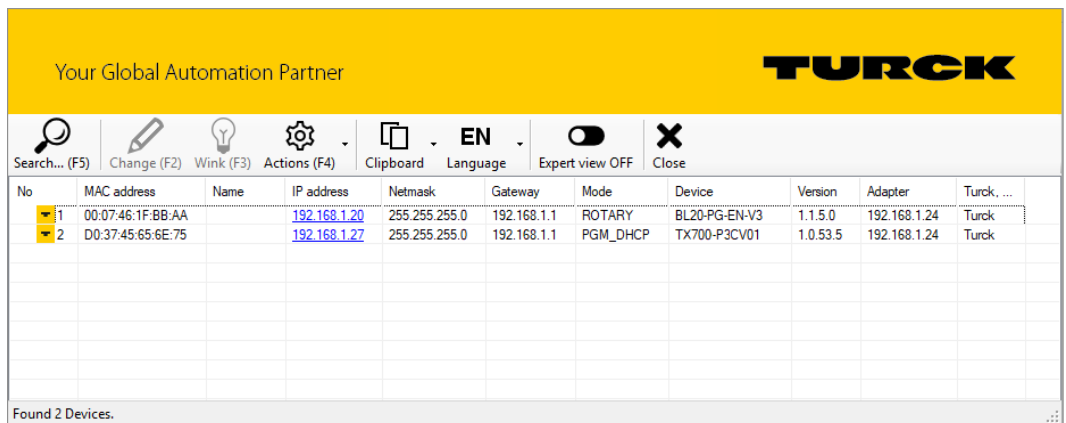

Fig. 19: Turck Service Tool – found devices

- ▶ Click on the desired device.
- ▶ Click **Change** or press [F2].
- ▶ Change the IP address and the net mask, if necessary.
- ▶ Accept the changes with **Set in device**.

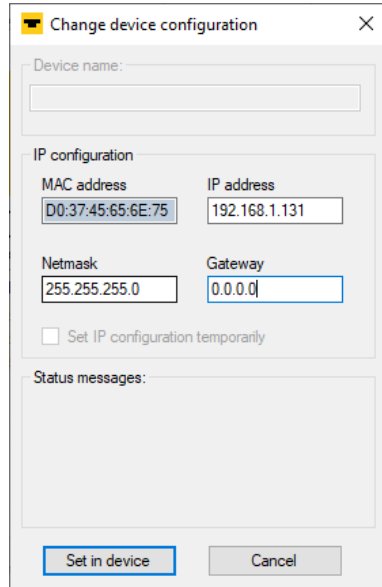

Fig. 20: Turck Service Tool – changing the IP configuration

7.6 Programming with CODESYS

The devices are delivered with a pre-installed CODESYS runtime.

The CODESYS software as well as the CODESYS package for the devices can be downloaded from www.turck.com.

Prerequisites

- CODESYS (≥ V 3.5.14.0) and the package “TXxxx HMI/PLC series” for the device have to be installed on a PC running Microsoft Windows.

7.7 Programming with TX VisuPro

Prerequisites

- For programming the HMI/PLCs with TX VisuPro, the software tool has to be installed on a PC computer running Microsoft Windows.
- If the WebVisu of TX VisuPro is to be used instead of the CODESYS-WebVisu, the TX VisuPro- Runtime must be installed first.
- Before installing TX VisuPro, the existing CODESYS runtime has to be deleted.
 - ▶ To delete the currently installed runtime, run the following command:
System Settings → Management → Data → Clear

7.7.1 Transferring TX VisuPro to the device

There are two options to transfer a TX VisuPro runtime project to a device:

- Via Ethernet
- Via a USB stick

Project transfer via Ethernet

- ▶ Connect the HMI device to the computer with an Ethernet network.
- ▶ Execute the command **Run/Download** in TX VisuPro. You may have to ensure that the proper firewall policy has been configured in the computer to allow TX VisuPro to access the network.

Project transfer via a USB stick

- ▶ Create an update package with TX VisuPro and copy it to a USB stick.

8 Configuring

The devices have an integrated User interface and a web server for configuring the system. The user interface is based on HTML pages accessible via port 443 using a Web browser (Firefox V.79 Chrome V.44 or higher). Alternatively, the system settings can be called and operated via a VNC client. To use the VNC client, the VNC service must be activated in the system settings.

Initial commissioning is done by local access to the system settings via the touch screen on the device. If the "System Settings" button is not displayed on the home screen, the device must be restarted in "Tap-Tap mode" (see "Recovery operation" in the "Adapting the system settings" [▶ 29]).

8.1 Configuring the system settings

The available options can be selected from the navigation menu on the left side of the screen.

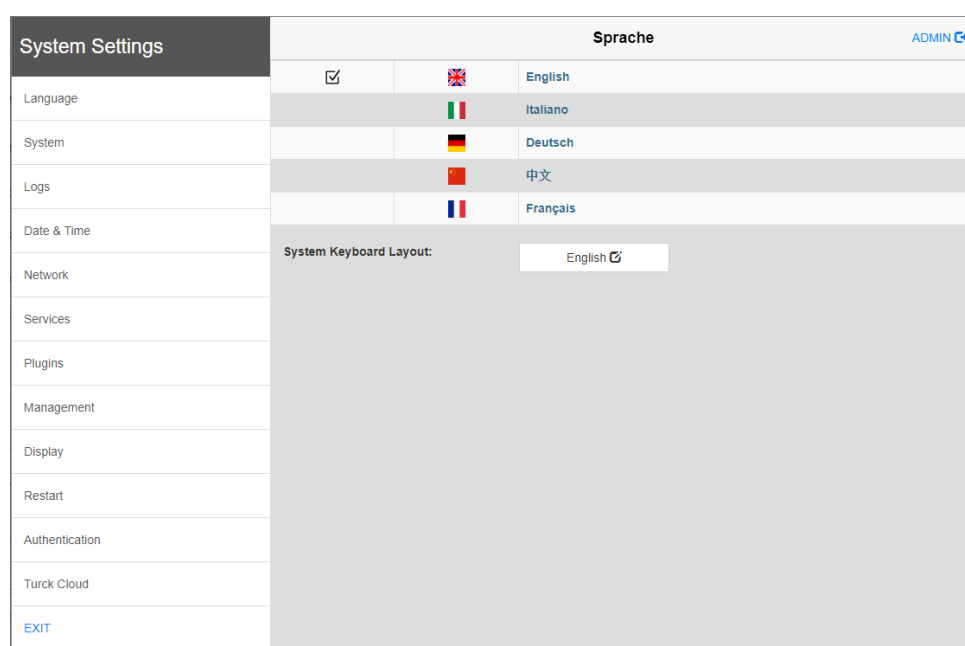

Fig. 21: System settings

System settings has two operating modes:

Mode	Usage
User mode	<ul style="list-style-type: none"> ■ Device with TX VisuPro runtime ■ Device in delivery state
System Mode	<p>In addition to the options in user mode, the system mode includes additional commands for system upgrade and recovery.</p> <ul style="list-style-type: none"> ■ Device without TX VisuPro runtime ■ Device with software error

Edit system settings in user mode

Status device	Description
Factory default status	▶ Open the system settings .
TX VisuPro runtime running	<ul style="list-style-type: none"> ▶ Press and hold the unused area of the touch screen for at least 2 s. ▶ Open the context menu and select System Settings.

Edit the system settings in system mode

Status device	Description
Standard	<p>If no TX VisuPro runtime is running on the device:</p> <p>User mode</p> <ul style="list-style-type: none"> ▶ Open the System Settings. <p>System Mode</p> <ul style="list-style-type: none"> ▶ Device without TX VisuPro runtime: Restart the device via Restart → Config. OS. ▶ Device with TX VisuPro runtime: Open the context menu and select System Settings. ▶ To open the context menu: Press and hold the unused area of the touch screen for at least 2 s. ▶ Restart the device via Restart → Config. OS.
Recovery operation	<p>If the device is not responsive, use the so-called “tap-tap” procedure.</p> <ul style="list-style-type: none"> ▶ Touch the surface of the touch screen several times with a typing frequency of at least 2 Hz immediately after switching on the device. <p>⇒ When the sequence is detected, the message "Tap Tap detected, Going to Config Mode" will appear on the display.</p>

The basic settings for the device are made in the system settings.

Setting	Description
Language	Configuration of the language used for the System Settings menu.
System	Information about platform, status and timers (“like System on time, “backlight on time”)
Logs	Activating and exporting persistent log for BSP
Date & Time	Date and time, including time zone and NTP Server
Network	Configuration of the IP address of the Ethernet interface and the other network settings like DNS, gateway, DHCP, host name, routing and bridging.
Services	Activate/deactivate services (e.g. OpenSSH server, bridge, cloud, router, SNMP, logging)
Management	Update of BSP components (Main OS, Config OS, Boot loader, XLoader), check for partitions consistence, update of splash screen, information about usage and size of partitions. The update of Main OS is available only in System Mode, the update of Config OS is only in User Mode.
Display	Configuring the automatic backlight, adjusting the brightness, changing the display orientation
Restart	Restarts the device By default, the device is restarted in user mode via the "Main OS" option. The "Configuration OS" option restarts the device directly in System Settings in system Mode.
Authentication	Configuration of the password for the administrator ("admin") and for the standard user ("user"). The administrator has full access to the system settings (updates of the BSP and other system components). The standard user has some restrictions.

9 Operating



DANGER

Changing components

Explosion hazard – Suitability for Class 1, Division 2 possibly impaired

- ▶ When replacing components, make sure that the suitability of the device for Class 1, Division 2 is not affected.
- ▶ Only use components that are suitable for use in Class 1, Division 2.
- ▶ If necessary, take measures to restore suitability for Class 1, Division 2.

9.1 LED displays

The device has the following LED displays:

- Status of the Ethernet ports

LED orange (left LED)	Meaning
off	No Ethernet connection
On	Ethernet connection established

LED green (right LED)	Meaning
On	No data transfer
Blinking	Data transfer

10 Troubleshooting

If the device does not function as expected, first check whether ambient interference is present. If there is no ambient interference present, check the connections of the device for faults.

If there are no faults, there is a device malfunction. In this case, decommission the device and replace it with a new device of the same type.

11 Maintenance

Dust layers on the display can lead to static electricity.

- ▶ To avoid dust layers on the display: Clean the device at regular intervals with a soft cloth and a neutral soap product.
- ▶ Do not use solvents.

12 Repair

The device must not be repaired by the user. The device must be decommissioned if it is faulty. When returning to Turck, please refer to our return policies.

12.1 Returning devices

Returns to Turck can only be accepted if the device has been equipped with a Decontamination declaration enclosed. The decontamination declaration can be downloaded from <https://www.turck.de/en/retoure-service-6079.php> and must be completely filled in, and affixed securely and weather-proof to the outside of the packaging.

13 Disposal

The device is equipped with a rechargeable lithium battery, which is not user replaceable.

- ▶ For disposal, open the back of the device and remove the battery.



The device the lithium battery must be disposed of properly in accordance with WEEE Directive 2012/19/EU and does not belong in normal household waste.

14 Technical Data

	TX705-P3CV01	TX707-P3CV01
Device		
Ident no.	100002029	100002030
Display/touch		
Display	TFT color	TFT color
Touch	Capacitive	Capacitive
Active image area	5"	7"
Resolution (pixels)	800 × 480	800 × 480
Format	16:9	16:9
Brightness	300 Cd/m ² typ.	500 Cd/m ² typ.
Dimmable	Yes (up to 0 %)	Yes (up to 0 %)
Viewing angle horizontal	<ul style="list-style-type: none"> ■ From the right: 50° ■ From the left: 70° 	70°
Viewing angle vertical	70°	<ul style="list-style-type: none"> ■ From above: 50° ■ From below: 70°
System		
CPU	ARM Cortex-A8, single core 1 GHz	ARM Cortex-A9, dual core 800 MHz
Operating system	Linux RT	Linux RT
Flash	4 GB	4 GB
RAM	1 GB	1 GB
Expansion memory	USB/SD card	USB/SD card
Real Time Clock	Yes (battery-backed)	Yes (battery-backed)
Accuracy RTC (at 25 °C)	< 100 ppm	< 100 ppm
Buzzer	Yes	Yes
SPS data		
Programming	CODESYS V3	CODESYS V3
Programming languages	IEC 61131-3 (IL, LD, FBD, SFC, ST)	IEC 61131-3 (IL, LD, FBD, SFC, ST)
Programming interface	Ethernet	Ethernet
Program memory	20 MB	20 MB
Non-volatile memory	63 kByte	63 kByte
Interfaces		
Ethernet ports	2 × 10/100 Mbit	1 × 10/100/1000 Mbit 2 × 10/100 Mbit
Serial ports (configurable)	1 × RS232/RS485/RS422	1 × RS232/RS485/RS422
USB Host port	1 × V2.0, max. 500 mA	2 × V2.0, max. 500 mA
SD card	Yes	Yes
Extension slot (plug-in)	1	2
<ul style="list-style-type: none"> ■ Max. number of plug-in modules 	2	4

	TX705-P3CV01	TX707-P3CV01
Power supply		
Rated value	24 VDC (SELV or Class 2)	24 VDC (SELV or Class 2)
Admissible voltage range	18...32 VDC	18...32 VDC
Current consumption at 24 VDC	0.6 A	0.7 A
Dimensions		
Housing (W × H)	147 × 107 mm	187 × 147 mm
Installation cut-out (W × H)	136 × 96 mm	176 × 136 mm
Installation depth (D)	52 mm	47 mm
Weight	0.8 kg	1.1 kg

	TX710-P3CV01	TX715-P3CV01	TX721-P3CV01
Device			
Ident no.	100002031	100002032	100002033
Display/touch			
Display	TFT color	TFT color	TFT color
Touch	Capacitive	Capacitive	Capacitive
Active image area	10.1"	15.6"	21.1"
Resolution (pixels)	1280 × 800	1366 × 768	1920 × 1080
Format	16:9	16:9	16:9
Brightness	500 Cd/m ² typ.	400 Cd/m ² typ.	300 Cd/m ² typ.
Dimmable	Yes	Yes	Yes
Viewing angle horizontal	85°	80°	89°
Viewing angle vertical	85°	80°	89°
System			
CPU	ARM Cortex-A9, dual core 800 MHz	ARM Cortex-A9, quad core 800 MHz	ARM Cortex-A9, quad core 800 MHz
Operating system	Linux RT	Linux RT	Linux RT
Flash	4 GB	8 GB	8 GB
RAM	1 GB	2 GB	2 GB
Expansion memory	USB/SD card	USB/SD card	USB/SD card
Real Time Clock	Yes (battery-backed)	Yes (battery-backed)	Yes (battery-backed)
Accuracy RTC (at 25 °C)	< 100 ppm	< 100 ppm	< 100 ppm
Buzzer	Yes	Yes	Yes
SPS data			
Programming	CODESYS V3	CODESYS V3	CODESYS V3
Programming languages	IEC 61131-3 (IL, LD, FBD, SFC, ST)	IEC 61131-3 (IL, LD, FBD, SFC, ST)	IEC 61131-3 (IL, LD, FBD, SFC, ST)
Programming interface	Ethernet	Ethernet	Ethernet
Program memory	20 MB	20 MB	20 MB
Non-volatile memory	63 kByte	63 kByte	63 kByte
Interfaces			

	TX710-P3CV01	TX715-P3CV01	TX721-P3CV01
Ethernet ports	1 × 10/100/1000 Mbit 2 × 10/100 Mbit	1 × 10/100/1000 Mbit 2 × 10/100 Mbit	1 × 10/100/1000 Mbit 2 × 10/100 Mbit
Serial ports (configurable)	1 × RS232/RS485/RS422	1 × RS232/RS485/RS422	1 × RS232/RS485/RS422
USB Host port	2 × V2.0, max. 500 mA	2 × V2.0, max. 500 mA	2 × V2.0, max. 500 mA
SD card	Yes	Yes	Yes
Extension slot (plug-in)	2	2	2
■ Max. number of plug-in modules	4	4	4
Power supply			
Rated value	24 VDC (SELV or Class 2)	24 VDC (SELV or Class 2)	24 VDC (SELV or Class 2)
Admissible voltage range	18...32 VDC	18...32 VDC	18...32 VDC
Current consumption at 24 VDC	1 A	1.2 A	1.7 A
Dimensions			
Housing (W × H)	282 × 197 mm	422 × 267 mm	552 × 347 mm
Installation cut-out (W × H)	271 × 186 mm	411 × 256 mm	541 × 336 mm
Installation depth (D)	56 mm	56 mm	56 mm
Weight	1.8 kg	3.5 kg	6.1 kg

	TX707HB-P3CV01	TX710HB-P3CV01
Device		
Ident no.	100007473	100007474
Display/touch		
Display	TFT color	TFT color
Touch	Capacitive	Capacitive
Active image area	7"	10.1"
Resolution (pixels)	800 × 480	1280 × 800
Format	16:9	16:9
Brightness	600 Cd/m ²	800 Cd/m ² typ.
Dimmable	Yes (up to 0 %)	Yes (up to 0 %)
Viewing angle horizontal	70 °	85°
Viewing angle vertical	■ From above: 50° ■ From below: 60°	85°
System		
CPU	ARM Cortex-A9, dual core, 800 MHz	ARM Cortex-A9, dual core, 800 MHz
Operating system	Linux RT	Linux RT
Flash	4 GB	4 GB
RAM	1 GB	1 GB
Expansion memory	USB/SD card	USB/SD card
Real Time Clock	Yes (battery-backed)	Yes (battery-backed)
Accuracy RTC (at 25 °C)	< 100 ppm	< 100 ppm
Buzzer	Yes	Yes

	TX707HB-P3CV01	TX710HB-P3CV01
SPS data		
Programming	CODESYS V3	CODESYS V3
Programming languages	IEC 61131-3 (IL, LD, FBD, SFC, ST)	IEC 61131-3 (IL, LD, FBD, SFC, ST)
Programming interface	Ethernet	Ethernet
Program memory	20 MB	20 MB
Non-volatile memory	63 kByte	63 kByte
Interfaces		
Ethernet ports	1 × 10/100/1000 Mbit 2 × 10/100 Mbit	1 × 10/100/1000 Mbit 2 × 10/100 Mbit
Serial ports (configurable)	1 × RS232/RS485/RS422	1 × RS232/RS485/RS422
USB Host port	2 × V2.0, max. 500 mA	2 × V2.0, max. 500 mA
SD card	Yes	Yes
Extension slot (plug-in)	2	2
■ Max. number of plug-in modules	4	4
Power supply		
Rated value	24 VDC (SELV or Class 2)	24 VDC (SELV or Class 2)
Admissible voltage range	18...32 VDC	18...32 VDC
Current consumption at 24 VDC	Max. 0.7 A	Max. 1.0 A
Dimensions		
Housing (W × H)	187 × 147 mm	282 × 197 mm
Installation cut-out (W × H)	176 × 136 mm	271 × 168 mm
Installation depth (D)	47 + 8 mm	56 + 8 mm
Weight	1.5 kg	2.5 kg

NOTE

For applications requiring compliance with EN 61131-2 and specifically in reference to 10 ms voltage dips, the minimum power supply voltage is 18 VDC.

Protection class according to EN 60529

Device front	IP66
Device rear	IP20

Environmental conditions		
Operating temperature (surrounding air temperature)	-20...+60 °C (vertical installation) Plug-in modules and USB devices may limit the maximum temperature to +50 °C	EN 60068- 2- 14
Storage temperature	-20...+70 °C	EN 60068-2-1 EN 60068-2-2 EN 60068-2-14
Operating and storage humidity	5...85 % RH, non condensing	EN 60068-2-30
Vibrations	5...9 Hz, 7 mmp-p 9...150 Hz, 1 g	EN 60068-2-6
Shock	± 50 g, 11 ms, 3 pulses per axis	EN 60068-2-27
Electromagnetic Compatibility (EMC)		
Radiation interference	Class A	CISPR 22, CISPR 16-2-3
Immunity		EN 61000-4-2
Electrostatic discharge	8 kV (air electrostatic discharge) 4 kV (contact electrostatic discharge)	
Radiation, high frequency, electromagnetic fields	80 MHz ... 1 GHz, 10 V/m 1.4 GHz ... 2 GHz, 3 V/m 2 GHz ... 2.7 GHz, 1 V/m	EN 61000-4-3
Burst	± 2 kV DC power port ± 1 kV signal line	EN 61000-4-4
Overvoltage	± 0.5 kV DC power port (line to earth) ± 0.5 kV DC power port (line to line) ± 1 kV signal line (line to earth)	EN 61000-4-5
Interference from high-frequency fields	0.15...80 MHz, 1 V	EN 61000-4-6
Power frequency magnetic field immunity test	Housing: 50/60Hz, 30A/m	EN 61000-4-8
Voltage dips, short interruptions, voltage fluctuations	Port: AC mains; Level: 100 % duration: 1 cycle and 250 cycles (50 Hz) 40 % duration: 10 cycles (50 Hz) 70 % duration: 25 cycles (50 Hz) phase: 0°...180°	
Test executed on the 230 VAC side of the power supply		EN 61000-4-11
	Port: DC mains 0 % duration: 10 ms 20 fields × 1 s	
Test executed on the 24 VDC of the EUT		EN 61000-4-29

Display durability

Backlight service life

Durability at 25 °C, continuous operation Time to darken the display to 50 % of the nominal value min. 40000 hours (LED type)



NOTE

Prolonged use at an ambient temperature of 40 °C or higher may result in a deterioration in the quality, reliability and durability of the backlight.

Display viewing angles

The viewing angles are included in the technical data of the respective device and are specified for the horizontal and vertical axis in relation to the vertical axis of the display. The specified angles always refer to the standard mounting orientation (landscape format).

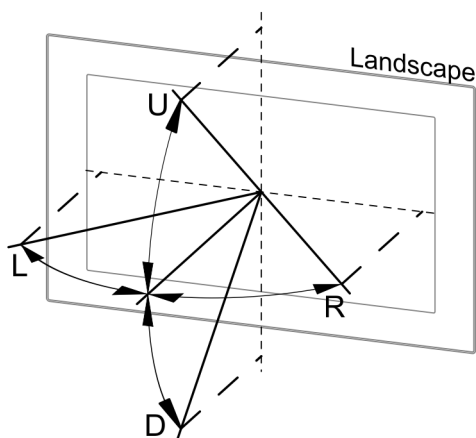

Fig. 22: Viewing angle

	Viewing angle
U	From the top
D	From the bottom
L	From the left
R	From the right

15 Appendix: Approvals and markings

Approvals	Marking according to ATEX directive	EN 60079-0/-15/-31
ATEX approval no.: DEMKO 20 ATEX 2333X	⊕ II 3 G ⊕ II 3 D	Ex nA IIC T5...T4 Gc Ex tc IIIC T95°C Dc
IECEX approval no.: IECEX ULD 20.0001X		Ex nA IIC T5...T4 Gc Ex tc IIIC T95°C Dc

Ambient temperature T_{amb} : 0...+50 °C or -20...+60 °C,
for mounting on the flat surface of a housing of type 12, 4X

Max. ambient temperature	Temperature Class
-20...+60 °C	T4
0...+50 °C	T5

Approvals	
CE	Immunity/emission <ul style="list-style-type: none"> ■ For industrial environments: EN 61000-6-2 EN 61000-6-4 ■ For residential, business and commercial areas and small businesses: EN 61000-6-1 EN 61000-6-3 ■ For marine environments: EN 60945 EN 61000-4-29 EN 60079-0 EN 6007915 EN 6007931
UL	cULus (UL File No. E484727) <ul style="list-style-type: none"> ■ UL 61010-1, 3rd Edition and UL 61010-2-201, 1st Edition ■ CAN/CSA C22.2 No. 61010-1, 3rd Edition and CAN/CSA C22.2 No. 61010-2-201:14 cULus (UL File No. E484803) <ul style="list-style-type: none"> ■ Class I, Division 2, Groups A, B, C and D
DNV-GL	Yes
LR	(not for TX707HB and TX710HB)

TURCK

Over 30 subsidiaries and over
60 representations worldwide!

100002669 | 2021/02



www.turck.com