

MA-M8-M30 Montageadapter

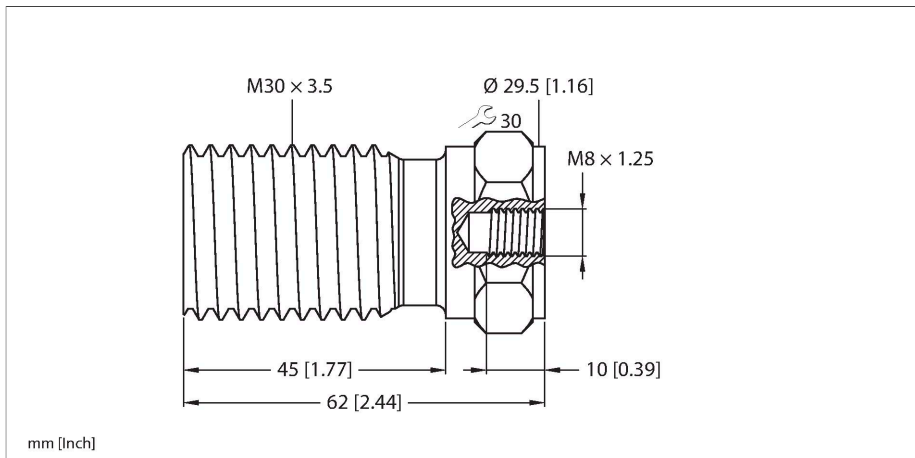

Technische Daten

Typ	MA-M8-M30
Ident-No.	100050785

Merkmale

- Innengewinde: M8 x 10mm
- Außengewinde: M30 x 45mm
- Edelstahl, V4A