

# MR15-Q80-IOLCJ-H1141

## Radar Sensor – Scanner for Object and Position Detection

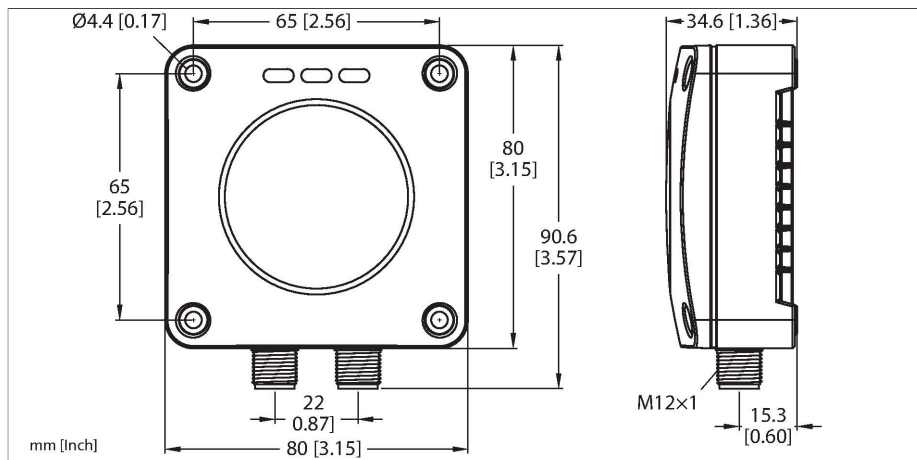

### Features

- Blind zone: 35 cm
- Range: 15 m
- Distance accuracy:  $\pm 2$  mm
- Angular accuracy:  $\pm 5^\circ$
- 3D sensing range: Adjustable max.  $120^\circ$
- Information about distance, angle, and object speed
- Radius and zone evaluation
- Data visualization via Turck Radar Monitor
- Approved acc. to ETSI 305550-2
- Approved acc. to FCC/CFR 47 Part 15.
- 2 x M12 x 1, 1 x 4-pin, 1 x 5-pin
- Operating voltage 9...33 VDC
- Switching output switchable between PNP/NPN
- IO-Link, SSP 4
- SAE J1939
- Rectangular 80 x 80
- Housing material PBT, AISi10Mg

### Wiring diagram

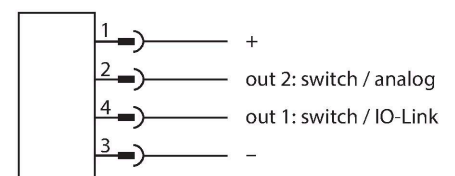
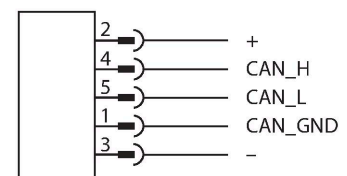

### Technical data

Type	MR15-Q80-IOLCJ-H1141
ID	100041054
<b>Radar data</b>	
Function	Radar scanner
Frequency range	60–64 GHz
Range	350...15000 mm
Resolution	1 mm
Minimum switching range	50 mm
Linearity error	$\leq \pm 0.3 \%$
Edge lengths of the nominal actuator	100 mm
Output power ERP	10 dBm
Output power EIRP	20 dBm
Cone angle	$120^\circ$
Repeatability	4 mm
<b>Electrical data</b>	
Operating voltage	9...33 VDC
Residual ripple	$< 10 \%$ $U_{ss}$
DC rated operational current	$\leq 250$ mA
No-load current	$\leq 400$ mA
Short-circuit protection	yes / Cyclic
Reverse polarity protection	yes
Communication protocol	IO-Link SAE J1939
Output function	NO/NC programmable, PNP/NPN
Output 2	Switching output
Voltage drop at $I_o$	$\leq 2$ V
Switching frequency	$\leq 10$ Hz

PRELIMINARY

## Technical data

Readiness delay	≤ 300 ms
Response time typical	< 70 ms
<b>IO-Link</b>	
IO-Link specification	V 1.1
IO-Link port type	Class A
Communication mode	COM 3 (230.4 kBaud)
Process data width	128 bit
Measured value information	128 bit
Switchpoint information	17 bit
Frame type	2.2
Minimum cycle time	3 ms
Function pin 4	IO-Link
Function Pin 2	DI
Maximum cable length	20 m
Profile support	Smart Sensor Profile
<b>Mechanical data</b>	
Design	Rectangular, Q80
Dimensions	90.6 x 80 x 34.6 mm
Housing material	Plastic, PBT-GF20 Die-cast aluminum alloy
Electrical connection	Connector, M12 × 1
Ambient temperature	-40...+85 °C
Storage temperature	-40...+85 °C
Protection class	IP67 IP68 IP69K
	Not assessed by UL
Power-on indication	LED, Green
Switching state	3-color LED, Yellow
Vibration resistance	20 g (10...2000 Hz), EN 60068-2-6
Shock test	EN 60068-2-27
Shock resistance	100 g (11 ms)
EMV	EN 61000-6-2:2019 ETSI EN 301489-3 v.1.6.1
Approvals	CE, ETSI, FCC, UL

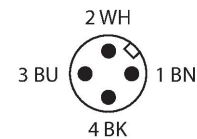

## Functional principle

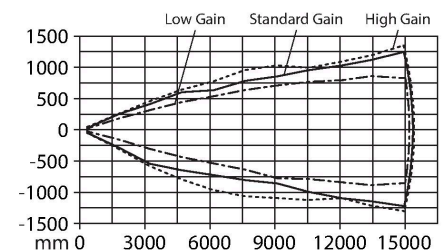

FMCW radar stands for frequency modulated continuous wave radar. FMCW is the English abbreviation for Frequency Modulated Continuous Wave. Non-modulated continuous wave radars have the disadvantage that they cannot measure distances due to lack of time reference. Such a time reference for distance measurement of stationary objects can be generated by means of frequency modulation. Using this method, a signal is emitted which continually changes the frequency. A periodic, linear frequency which varies upwards and downwards is used to limit the frequency range and to simplify the signal evaluation. The factor for the rate of change  $df/dt$  remains constant. If an echo signal is received, then this has a runtime delay as with the pulse radar, and thus a different frequency that is proportional to the distance.



## Accessories

Dimension drawing	Type	ID	
	TBEN-S2-4IOL	6814024	Compact multiprotocol I/O module, 4 IO-Link Master 1.1 Class A, 4 universal PNP digital channels 0.5 A
	RR-6	100047726	

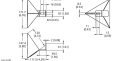
PRELIMINARY

Dimension drawing	Type	ID
	RR-12	100047727
	RR-20	100047728