

RI360P0-QR24M0-CNX4-2H1150

Contactless Encoder – CANopen

Premium Line

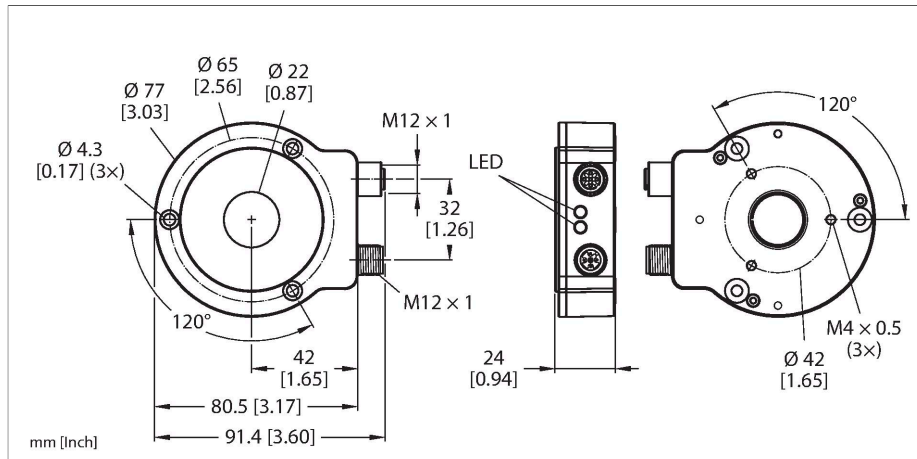

Technical data

Type	RI360P0-QR24M0-CNX4-2H1150
ID	1590914
Measuring principle	Inductive
General data	
Max. rotational speed	2000 rpm
Starting torque shaft load (radial / axial)	Determined with standardized construction, with a steel shaft Ø 20 mm, L = 50 mm and reducer Ø 20 mm not applicable, because of contactless measuring principle
Measuring range	0...360 °
Nominal distance	1.5 mm
Repeat accuracy	≤ 0.01 % of full scale
Linearity deviation	≤ 0.05 % f.s.
Temperature drift	≤ ± 0.003 %/K
Output type	Absolute singleturn
Resolution singleturn	16 Bit
Electrical data	
Operating voltage U_B	10...30 VDC
Ripple U_{ss}	≤ 10 % U_{Bmax}
Isolation test voltage	0.5 kV
Wire break/reverse polarity protection	yes (voltage supply)
Communication protocol	CANopen
Interface	CANopen, DS406 device profile, LSS DS 305
Node ID	1...127; Werkseinstellung: 3
Baud rate	10/20/50/125/250/500/1000 kbps, factory setting 125 kbps

Features

- Compact, rugged housing
- Many mounting possibilities
- Status displayed via LED
- Positioning element and aluminium ring not incl.
- CANopen interface
- Baud rate 10 kbps up to 1 Mbps; Factory setting: 125 kbps
- Node address 1 to 127; Factory setting 3
- Terminating resistor switched in via - CANopen device access
- Immune to electromagnetic interference
- 10 ... 30 VDC
- M12 x 1 male, 5-pin, CAN in, CAN out
- Acc. to CiA DS-301, CiA 305, CiA 406

Wiring diagram

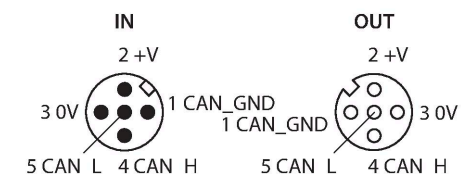

Functional principle

The measuring principle of inductive angle sensors is based on oscillation circuit coupling between the positioning element and the sensor, whereby an output signal is provided proportional to the angle of the positioning element. The rugged sensors are wear and maintenance-free, thanks to the contactless operating principle. They convince through their excellent repeatability, resolution and linearity within a broad temperature range. The innovative technology ensures a high immunity to electromagnetic DC and AC fields.

Technical data

Sample rate	800 Hz
Current consumption	< 60 mA
Mechanical data	
Design	QR24
Dimensions	81 x 78 x 24 mm
Flange type	Flange without mounting element
Shaft Type	Hollow shaft
Shaft diameter D (mm)	6 6.35 9.525 10 12 12.7 14 15.875 19.05 20
Housing material	Metal/plastic, ZnAlCu1/PBT-GF30-V0
Electrical connection	Connector, M12 × 1
Environmental conditions	
Ambient temperature	-25...+85 °C Acc. to UL approval to +70 °C
Vibration resistance	55 Hz (1 mm)
Vibration resistance (EN 60068-2-6)	20 g; 10...3000 Hz; 50 cycles; 3 axes
Shock resistance (EN 60068-2-27)	100 g; 11 ms ½ sine; 3 × each; 3 axes
Continuous shock resistance (EN 60068-2-29)	40 g; 6 ms ½ sine; 4000 × each; 3 axes
Protection class	IP68 IP69K
MTTF	138 years acc. to SN 29500 (Ed. 99) 40 °C
Power-on indication	LED, Green
Status CANopen	Green/red
Measuring range display	LED, yellow, yellow flashing
Included in delivery	Mounting aid MT-QR24, closure cap VZ 3
UL certificate	E210608

Mounting instructions

Mounting instructions/Description

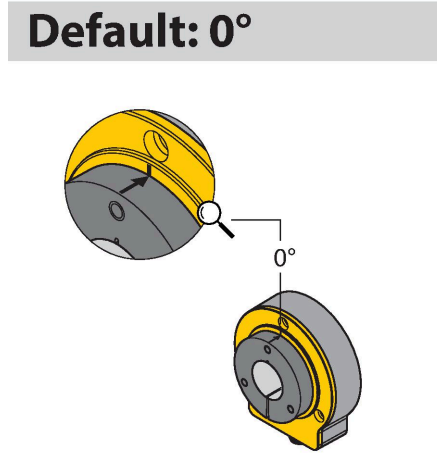
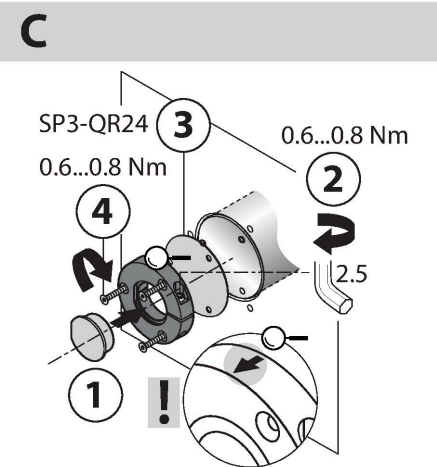
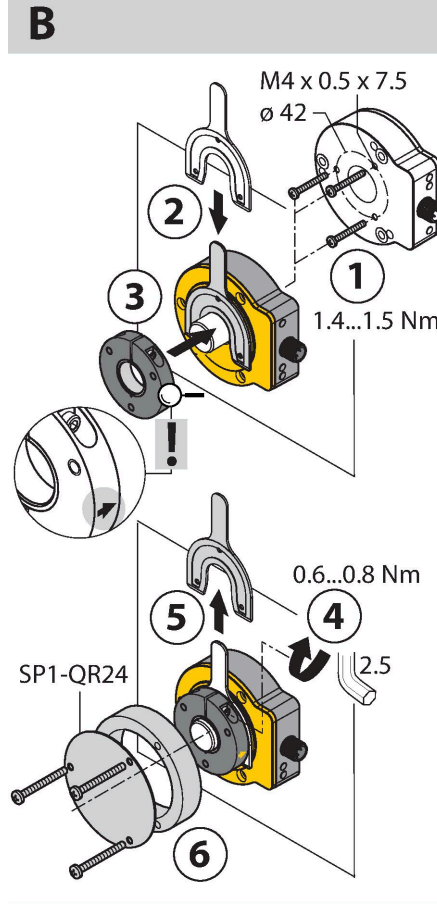
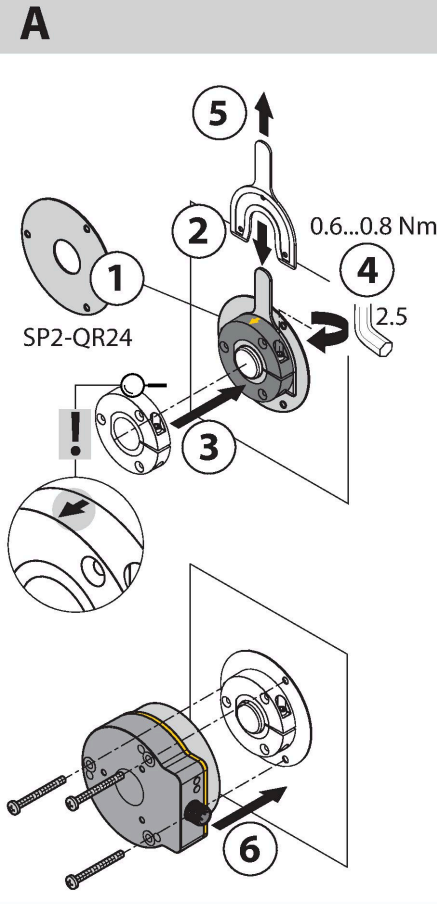

Extensive range of mounting accessories for easy adaptation to many different shaft diameters. Based on the functional principle of RLC coupling, the encoder is immune to magnetized metal splinters and other interferences.

The adjacent figure shows the two separate units, sensor and positioning element.

Mounting option A:

First, interconnect positioning element and rotatable shaft with the bracket. Then place the encoder above the rotating part in such a way that you get a tight and protected unit.

Mounting option B:

Push the encoder on the back site of the shaft and fasten it to the machine. Then clamp the positioning element to the shaft with the bracket.

Mounting option C:

If the positioning element is screwed on a rotating machine part and not to a shaft, you must first put on the dummy plug RA8-QR24. Then tie up the bracket. Screw on the encoder via the three bores.

When mounting, ensure that the positioning element is correctly aligned towards the sensor's active face. For correct fitting see arrow on the edge of the positioning element. (Arrow must point in direction of sensor)

Due to the separate installation of positioning element and sensor no electrical currents or harmful mechanical forces are transmitted via the shaft to the sensor. The encoder also offers a high degree of protection for life and stays permanently sealed.

The accessories enclosed in the delivery help to mount encoder and positioning element at an optimal distance from each other. LEDs indicate the switching status. Optionally, you can use the shield plates which are included in the accessories to increase the allowed distance between positioning element and sensor.

Status / Power LED:

Green:

Sensor is properly supplied, positioning element in the coverage

Yellow:

Positioning element is in the measuring range, signal low (e.g. distance too large)

Yellow flashing:

Positioning element is outside the coverage

Status CAN

Green / Red: CAN communication active / not active

Red / Green alternating: LSS services active

Green flashing: Pre-operational state

Green 1 x flashing: CAN communication stopped

Red 2 x flashing: Error control event

Red 3 x flashing: Sync Error

Accessories

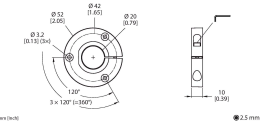
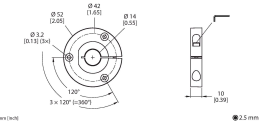
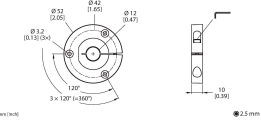
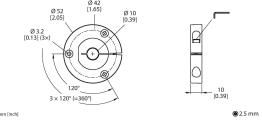
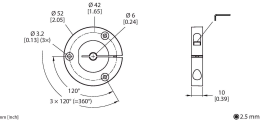
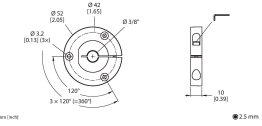
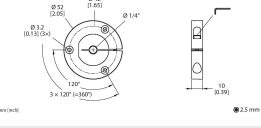
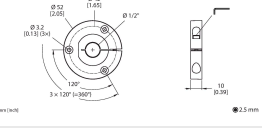
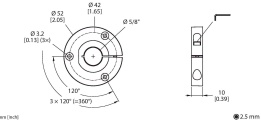
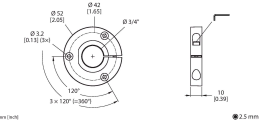
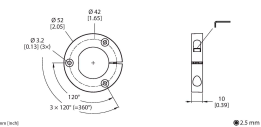
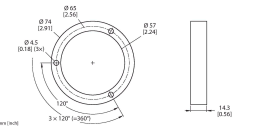
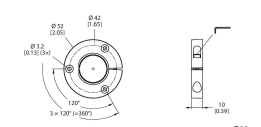
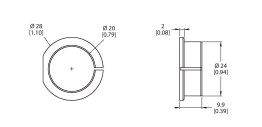
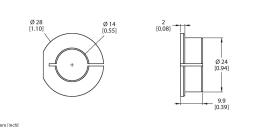
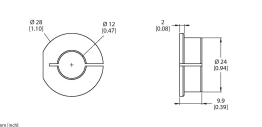
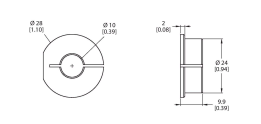
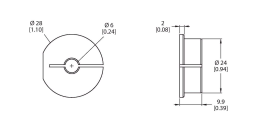
P1-RI-QR24	1590921	Positioning element, for \varnothing 20 mm shafts	P2-RI-QR24	1590922	Positioning element, for \varnothing 14 mm shafts
					
P3-RI-QR24	1590923	Positioning element, for \varnothing 12 mm shafts	P4-RI-QR24	1590924	Positioning element, for \varnothing 10 mm shafts
					
P5-RI-QR24	1590925	Positioning element, for \varnothing 6 mm shafts	P6-RI-QR24	1590926	Positioning element, for \varnothing 3/8" shafts
					
P7-RI-QR24	1590927	Positioning element, for \varnothing 1/4" shafts	P9-RI-QR24	1593012	Positioning element for installation on \varnothing 1/2" shafts
					
P10-RI-QR24	1593013	Positioning element for installation on \varnothing 5/8" shafts	P11-RI-QR24	1593014	Positioning element for installation on \varnothing 3/4" shafts
					
P8-RI-QR24	1590916	Positioning element with blanking plug for large shafts	M1-QR24	1590920	Aluminum protecting ring, for inductive encoders RI-QR24
					
PE1-QR24	1590937	Positioning element without adapter sleeve	RA1-QR24	1590928	Adapter sleeve, for \varnothing 20 mm shafts
					
RA2-QR24	1590929	Adapter sleeve, for \varnothing 14 mm shafts	RA3-QR24	1590930	Adapter sleeve, for \varnothing 12 mm shafts
					
RA4-QR24	1590931	Adapter sleeve, for \varnothing 10 mm shafts	RA5-QR24	1590932	Adapter sleeve, for \varnothing 6 mm shafts
					

RA6-QR24 1590933 Adapter sleeve, for Ø 3/8" shafts

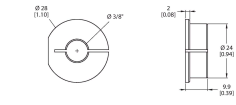

RA7-QR24 1590934 Adapter sleeve, for Ø 1/4" shafts

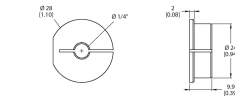

RA9-QR24 1590960 Adapter sleeve, for Ø 1/2" shafts

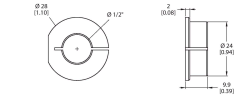

RA10-QR24 1590961 Adapter sleeve, for Ø 5/8" shafts

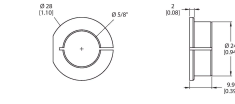

RA11-QR24 1590962 Adapter sleeve, for Ø 3/4" shafts

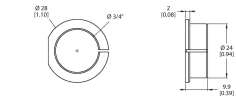

RA8-QR24 1590959 Plug for mounting option C

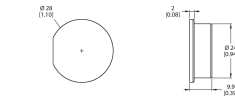

SP1-QR24 1590938 Shield plate Ø 74 mm, aluminium



SP2-QR24 1590939 Shield plate Ø 74 mm, aluminium, with borehole for shaft feedthrough

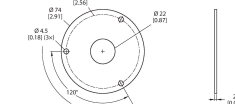

SP3-QR24 1590958 Shield plate Ø 52 mm, aluminium

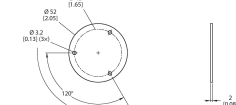

MT-QR24 1590935 Mounting aid for optimal alignment of positioning element

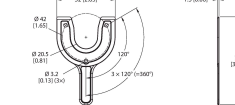

Accessories

Dimension drawing	Type	ID
	RKC5701-5M	6931034

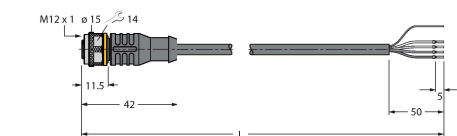

Bus cable for CAN (DeviceNet, -CANopen), M12 female connector, straight, cable length: 5 m, jacket material: PUR, anthracite; cULus approval