

RU100U-M18MS-UP8X2-H1151

Ultrasonic Sensor – Diffuse Mode Sensor

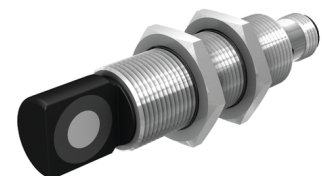
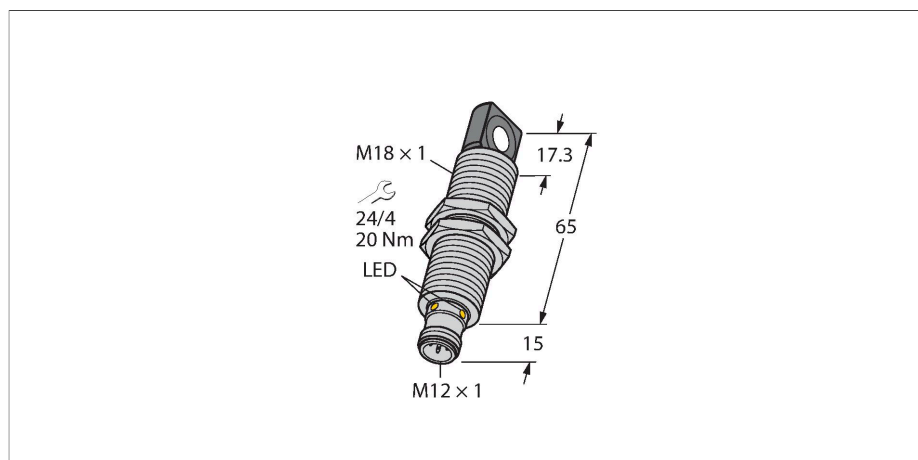

Technical data

Type	RU100U-M18MS-UP8X2-H1151
ID	1610011
Ultrasonic data	
Function	Proximity switch
Range	150...1000 mm
Resolution	1 mm
Minimum switching range	10 mm
Ultrasound frequency	200 kHz
Repeat accuracy	≤ 0.15 % of full scale
Temperature drift	± 1.5 % of full scale
Linearity error	≤ ± 0.5 %
Edge lengths of the nominal actuator	100 mm
Approach speed	≤ 8 m/s
Pass speed	≤ 2 m/s
Electrical data	
Operating voltage	15...30 VDC
Residual ripple	10 % U _{ss}
DC rated operational current	≤ 150 mA
No-load current	≤ 50 mA
Load resistance	≤ 1000 Ω
Residual current	≤ 0.1 mA
Response time typical	< 90 ms
Readiness delay	≤ 300 ms
Output function	NO/NC, PNP
Output 1	Switching output
Switching frequency	≤ 6.9 Hz
Hysteresis	≤ 10 mm

Features

- Rectangular transducer front
- Cylindrical housing M18, potted
- Connection via M12 x 1 male
- Temperature compensation
- Blind zone: 15 mm
- Range: 100 cm
- Resolution: 1 mm
- Aperture angle of sonic cone: ±16 °
- 1 × switching output, PNP
- Teachable settings
- NO/NC programmable

Wiring diagram

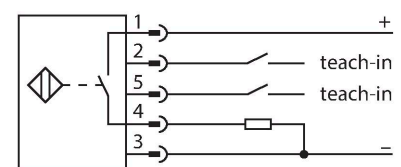

Functional principle

Ultrasonic sensors capture a multitude of objects contactlessly and wear-free with ultrasonic waves. It does not matter whether the object is transparent or opaque, metallic or non-metallic, firm, liquid or powdery. Even environmental conditions such as spray, dust or rain hardly affect their function. The sonic cone diagram indicates the detection range of the sensor. In accordance with standard EN 60947-5-2, quadratic targets in a range of sizes (20 × 20 mm, 100 × 100 mm) and a round rod with a diameter of 27 mm are used. Important: The detection ranges for other targets may differ from those for standard targets due to the different reflection properties and geometries.

Technical data

Voltage drop at I _e	≤ 2.5 V
Short-circuit protection	yes / Cyclic
Reverse polarity protection	yes
Wire breakage protection	yes
Setting option	Remote Teach
Mechanical data	
Design	Threaded barrel, M18
Radiation direction	side
Dimensions	Ø 18 x 80 mm
Housing material	Metal, CuZn, Nickel Plated
Max. tightening torque of housing nut	20 Nm
Transducer material	Plastic, Epoxyd resin and PU foam
Electrical connection	Connector, M12 × 1, 5-wire
Ambient temperature	-25...+70 °C
Storage temperature	-40...+80 °C
Pressure resistance	0.5...5 bar
Protection class	IP67
Switching state	LED, Yellow
Object detected	LED, Green
Tests/approvals	
MTTF	281 years acc. to SN 29500 (Ed. 99) 40 °C
Declaration of conformity EN ISO/IEC	EN 60947-5-2
Vibration resistance	IEC 60068-2
Approvals	CE cULus

Sonic Cone

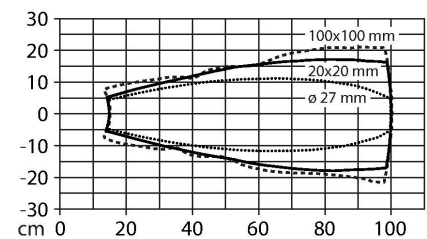

Mounting instructions

Mounting instructions/Description

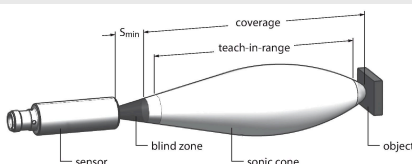

LED			
	GN	YE	off

Single switching point: measure and save	GND > 2 s	OK	3 Hz
Invert logic	U _B > 2 s	OK	2 Hz

Setting the switching point

The ultrasonic sensor features a switching output with a teachable switching point. The green and yellow LEDs indicate whether the sensor has detected the object.

One switching point is taught. This must be within the detection range. In this operating mode the background is suppressed.

Easy-Teach

Connect the TX1-Q20L60 teach adapter between the sensor and connection cable. Place object at the end of the switching range. Press and hold button for at least 2 s against Gnd.

After a successful teach-in, the green LED flashes at 3 Hz and the sensor runs automatically in normal mode.

To invert the output function, press and hold the button against the U_B for 2...7 s.

LED response

In standard operating mode, the two LEDs indicate the switching state of the sensor.
 Green: Object within the detection range but not in switching range
 Yellow: Object is within the switching range
 Off: Object is outside the detection range or signal loss

Accessories

MW-18

6945004

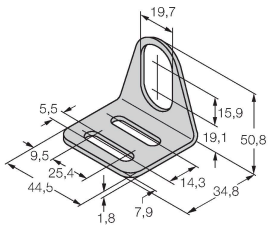

Mounting bracket for threaded barrel sensors; material: Stainless steel A2 1.4301 (AISI 304)

Accessories

Dimension drawing	Type	ID	
	RKC4.5T-2/TEL	6625016	Connection cable, M12 female connector, straight, 5-pin, cable length: 2 m, jacket material: PVC, black; cULus approval



	WKC4.5T-2/TEL	6625028	Connection cable, M12 female connector, angled, 5-pin, cable length: 2 m, jacket material: PVC, black; cULus approval
--	---------------	---------	---

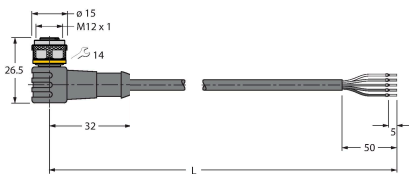

Accessories

Dimension drawing	Type	ID	
	TX1-Q20L60	6967114	Teach adapter for inductive encoders, linear position, angle, ultrasonic and capacitive sensors

