

Accessories

Compression Fitting

For Temperature Sensors

CF-M-6-M18-A4

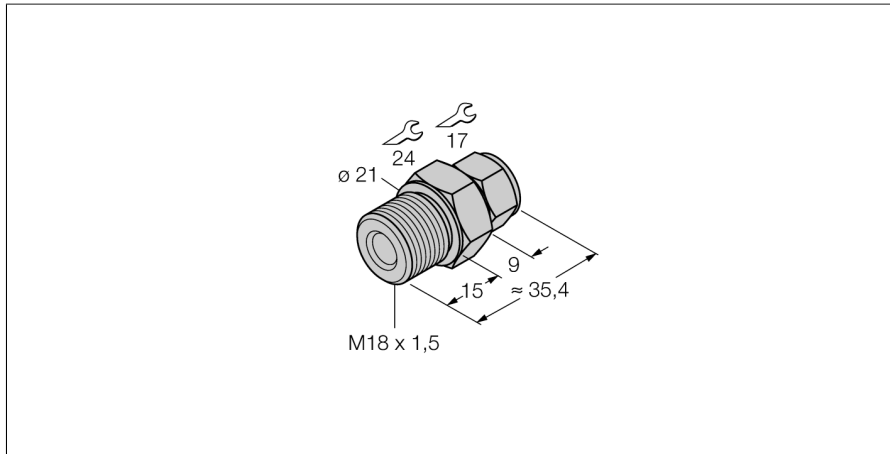

- Compression fittings for direct mounting of TP temperature probes
- Metal compression fitting
- For probe with 6 mm diameter
- Process connection M18 × 1 male thread

General description

With compression fittings, probes can be mounted directly where they are needed and they can be immersed as deep as wanted. Through direct contact with the medium, they react immediately to temperature changes.

Type	CF-M-6-M18-A4
ID	9910525
Temperature range	
Measuring range	-50...350 °C
	-58...662 °F
Mechanical data	
Housing material	Stainless steel, 1.4404 (AISI 316L)
Sealing material	stainless steel
Internal diameter	7 mm
Process connection	M18 × 1 male thread
Pressure resistance	100 bar
Max. tightening torque of housing nut	100 Nm

Accessories

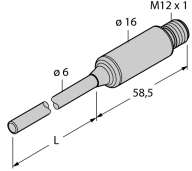
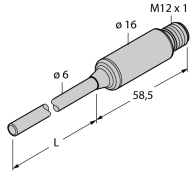
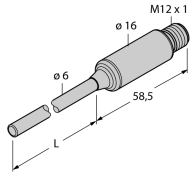
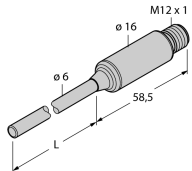
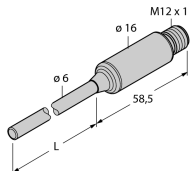
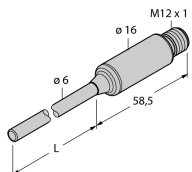
Type code	Ident no.		Dimension drawing
TTMS-206A-CF-LI-UPN-H1140-L100	9910660	stainless steel transmitter with integrated probe	
TTMS-206A-CF-LI-UPN-H1140-L100/S713	9910661	stainless steel transmitter with integrated probe	
TTMS-206A-CF-LI-UPN-H1140-L150	9910662	stainless steel transmitter with integrated probe	
TTMS-206A-CF-LI-UPN-H1140-L150/S713	9910663	stainless steel transmitter with integrated probe	
TTMS-206A-CF-LI6-H1140-L100-50/150	100004227	stainless steel transmitter with integrated probe	
TTMS-206A-CF-LI6-H1140-L200-50/150	100004734	stainless steel transmitter with integrated probe	

Accessories

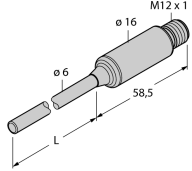
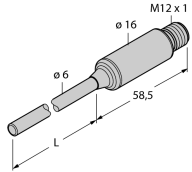
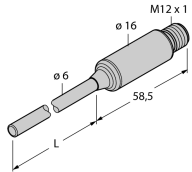
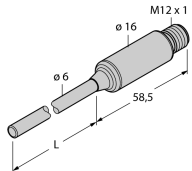
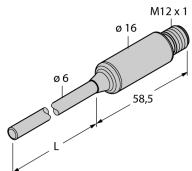
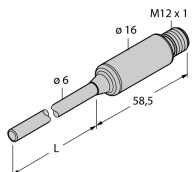
Type code	Ident no.		Dimension drawing
TTMS-206A-CF-LI6-H1140-L150-50/150	100004735	stainless steel transmitter with integrated probe	
TTMS-206A-CF-LI-UPN-H1140-L050	100006167	stainless steel transmitter with integrated probe	
TTMS-206A-CF-LI-UPN-H1140-L075	100022284	stainless steel transmitter with integrated probe	
TTMS-206A-CF-LI6-H1140-L050-50/150	100025946	stainless steel transmitter with integrated probe	
TTMS-206A-CF-LI6-H1140-L50-50/150	100004227_USA	stainless steel transmitter with integrated probe	
TTMS-206A-CF-LI-UPN-H1140-L300	100046031	stainless steel transmitter with integrated probe	

Accessories

Type code	Ident no.		Dimension drawing
TTMS-206A-CF-LIUPN-H1140-L050-25/100°C	100047517	stainless steel transmitter with integrated probe	
TTMS-206A-CF-LI-UPN-H1140-L600	100049953	stainless steel transmitter with integrated probe	
TTMS-206A-CF-LI6-H1140-L100-0/100	100050213	stainless steel transmitter with integrated probe	
TTMS-206A-CF-LI6-H1140-L600-0/100	100050214	stainless steel transmitter with integrated probe	
TTMS-206B-CF-LI6-H1140-L400-0/500	100050472	stainless steel transmitter with integrated probe	
TTMS-206A-CF-LI6-H1140-L100-20/80	100050799	stainless steel transmitter with integrated probe	

Accessories

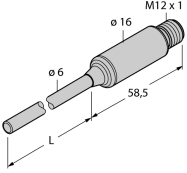
Type code	Ident no.		Dimension drawing
TTMS-206A-CF-LI6- H1140-L600-20/80	100050800	stainless steel transmitter with integrated probe	
TTMS-206A-CF-LI6- H1140-L150-0/150	100051610	stainless steel transmitter with integrated probe	