

WSM WKM 5723-2M

Bus Cable for CAN (DeviceNet, CANopen) – TPU Cable Jacket

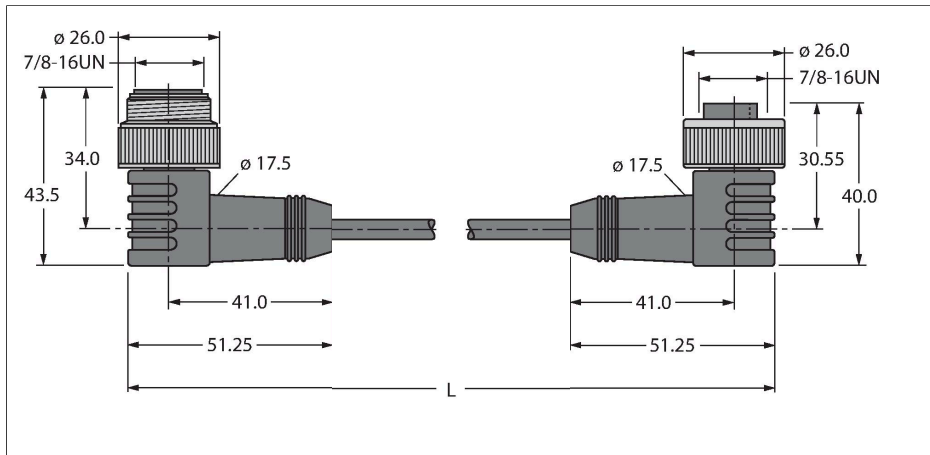

Features



- Jacket material: PUR
- Jacket color: gray
- Suitable for drag chain use
- UL approval
- 7/8" female, angled
- 7/8" male, angled
- Cable length: 2.0 m

Cable Cross-Section

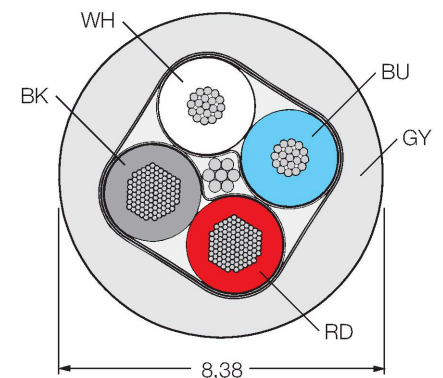

Contact assignment



Technical data

Type	WSM WKM 5723-2M
ID	U8726-2
Connector A	Male, 7/8"-16 UN, Angled
Number of pins	5
Contacts	Metal, CuZn, Gold-plated
Contact carriers	Plastic, TPU, Blue
Connector body	Plastic, TPU, Blue
Coupling nut/screw	Brass, CuZn, Nickel-plated
Mechanical lifespan	> 100 Mating cycles
Pollution degree	3
Protection class	IP67, Only in screwed condition
Connector B	Female, 7/8"-16 UN, Angled
Number of Pins	5
Contacts	Metal, CuZn, Gold-plated
Contact carriers	Plastic, TPU, Blue
Connector body	Plastic, TPU, Blue
Coupling nut/retaining screw	Brass, CuZn, Nickel-plated
Mechanical life	> 100 Mating cycles
Protection class	IP67, Only when screwed together
Cable	
Network protocol	DeviceNet CANopen, 5723
Cable diameter	Ø 8.38 mm
Cable length	2 m
Cable jacket	TPU, Gray
Shielding	yes

Technical data

Core insulation	PE (Data), PVC (Power)
Data cable cores	
Core cross-section	2 x 0.52 mm ²
Arrangement of strands	41 x 0.1 mm
Power cable cores	
Core cross-section	2x 1.04 mm ²
Litz wire arrangement	82 x 0.1 mm
Core colors	Power: RD, BK, Data: WH, BU
Electrical properties at +20 °C	
Rated voltage	300 V
Current	7 A
DC resistance (loop)	34.1 Ω/km
Nom. impedance	110 Ω (1 MHz)
Nom. capacitance	40.52 pF/m
Mechanical and chemical properties	
Bending radius (stationary installation)	≥ 5 x Ø
Bending radius (flexible use)	≥ 15 x Ø
Ambient temperature (fixed)	-40...+80 °C
Other Features	
Qualified for drag chain use	yes
Halogen-free	no
Approvals	UL CSA
Note	
- We reserve the right to make technical modifications without prior notice.	